



ELIXIR

Airplane Flight Manual & Pilot's Operating Handbook

Model
Airplane Serial Number
Airplane Registration Marks

ELIXIR
MSN

Type Certificate No.



This manual includes the information that the conditions of certification require to provide to the pilot.

*THIS DOCUMENT MUST BE ON BOARD THE AIRPLANE ALL THE TIME.
THE AIRPLANE MUST BE OPERATED ACCORDING TO THE INFORMATIONS AND
LIMITATIONS CONTAINED IN THE HANDBOOK*

Issue: July 27, 2022

Intentionally left blank

0 Handbook Management

0.1 Record of revisions

Updates are classified as “Editions” and “Revisions”.

An Edition (Ed.) is a change of the AFM, with an impact on the approved chapters. Any new Edition is EASA approved and mandatory.

A Revision (Rev.) is an update of the AFM, providing additional information, on non-approved chapters. Update your aeroplane documentation with new revisions at your own discretion

The Revision number is re-set to 01 at soon as a new Edition is released.

Rev. N°	Revised pages	EASA Approval date	Description of Revision
Ed.01 Rev.01	all	17/03/2022	Initial release
Ed.02 Rev.01	all		NVFR capacity Control deflection tolerance clarification Section 9 Supplements reorganisation

Intentionally left blank

0.2 AFM sections overview

0	Handbook Management.....	0-3
1	General information	1-1
2	Limitations	2-1
3	Emergency Procedures.....	3-1
4	Normal procedures	4-1
5	Performance	5-1
6	Weight & Balance	6-1
7	Airplane & Systems Descriptions	7-1
8	Airplane Handling, Servicing & Maintenance.....	8-1
9	Supplements.....	9-1
10	Supplemental procedures	10-1

Intentionally left blank

1 General information

1.1	Introduction	1-2
1.2	Certification basis.....	1-2
1.3	Warnings, Cautions and Notes.....	1-3
1.4	Symbols, Abbreviations & Terminology	1-4
1.4.1	General Airspeed Terminology and Symbols	1-4
1.4.2	Meteorological Terminology.....	1-4
1.4.3	Systems and Instruments	1-4
1.4.4	Airplane Performance and Flight planning terminology	1-5
1.4.5	Weight and Balance	1-5
1.4.6	Units of measurements.....	1-6
1.5	Aircraft description and dimensions.....	1-7
1.5.1	Airplane manufacturer	1-7
1.5.2	Three view Drawings	1-8
1.5.3	Main airplane dimensions, control surface deflections	1-9

1.1 Introduction

This Pilot's Operating Handbook (POH) has been prepared to provide pilots with information required for the safe and efficient operation of the Elixir aircraft. This manual includes the information required by CS23 to be furnished to the pilot. It also contains supplemental information provided by the aircraft manufacturer.

As the pilot you must be thoroughly familiar with the content of this Handbook.

You must operate the airplane within the Limitations specified in this Handbook, in Section 2 and including supplements in Section 9.

The Normal Procedures section of this handbook (Section 4) was designed to provide guidance for day-to-day operation of this airplane. The procedure given are the result of flight testing, certification requirements, and input from pilots with a variety of operational experience. Become fully familiar with the procedures, perform all the required checks, and operate the airplane within the limitations and as outlined in the procedures.

1.2 Certification basis

The airplane is certified according to EASA Certification Specifications for Normal-Category Aeroplanes CS23 Amendment 5 dated 29/03/2017.

Type Certificate number : EASA.A.633.

1.3 Warnings, Cautions and Notes

The following definitions apply to warnings, cautions and notes in the POH

WARNING

Means that the non-observation of the corresponding procedure leads to an immediate or important degradation of the flight safety.

Caution

Means that the non-observation of the corresponding procedure leads to a minor or to a more or less long-term degradation of the flight safety.

Note

Draws the attention to any special item not directly related to safety but which is important or unusual.

1.4 Symbols, Abbreviations & Terminology

1.4.1 General Airspeed Terminology and Symbols

CAS	Calibrated Air Speed. (indicated airspeed corrected for instrument and static/total pressure probe position errors)
GS	Ground Speed
IAS	Indicated Airspeed (shown on the airspeed indicator)
TAS	True Airspeed
V_A	Manoeuvring Speed
V_{FE}	Maximum Flaps Extended Speed
V_{NE}	Never Exceed Speed
V_{NO}	Maximum Structural Cruising Speed (not be exceeded, except in smooth air, only with caution)
V_S"x"	Stalling Speed in the configuration "x"
V_{S0}	Stalling Speed in landing configuration
V_X	Best Angle-of-Climb speed
V_Y	Best Rate-of-Climb speed

1.4.2 Meteorological Terminology

ISA	International Standard Atmosphere
OAT	Outside Air Temperature is the free air static temperature. It is expressed in either degrees Celsius or degrees Fahrenheit.
Standard Temperature	ISA Standard Temperature is 15°C at sea level pressure altitude and decrease by 2°C for each 1000 feet of altitude.
"ISA ±xx °C"	Deviation from standard temperature: actual OAT is xx° above or below ISA standard.
VMC	Visual Meteorological Conditions

1.4.3 Systems and Instruments

A/P	Autopilot
ADAHRS	Air Data and Attitude/Heading Reference System
ADC	Air Data Computer
ADI	Attitude Indicator
AHRS	Attitude and Heading Reference System
ALT	Altimeter
ASI	Airspeed Indicator
COMM	Communication transceiver
EFIS	Electronic Flight Information System

EGT	Exhaust gas temperature
EIS	Engine Indication System
EMS	Engine Monitoring System
GPS	Global Position System
HSI	Horizontal Situation Indicator
LDG	Flaps in Landing position (37°)
MFD	Multi-Function Display
PFD	Primary Flight Display
T/O	Flaps in Take-Off position (15°)
VSI	Vertical Speed Indicator

1.4.4 Airplane Performance and Flight planning terminology

Demonstrated crosswind	Velocity of the crosswind component for which adequate control of the airplane during take-off and landing was demonstrated during certification tests (this is not a limitation)
Landing distance	The distance from 15 m height to full stop
Landing run	The distance from touch down to full stop
MSL	Mean sea level
Take off distance	The distance from brakes release to a 15 m height
Take off run	The distance from brakes release to lift off
Usable Fuel	The fuel available for flight planning
Unusable Fuel	Is the fuel quantity that cannot be safely used in flight

1.4.5 Weight and Balance

Arm	Arm is the horizontal distance from the reference datum to the centre of Gravity (C.G.) of an item.
CG	Centre of Gravity is the point at which an airplane, or equipment would balance if suspended.
Moment	Moment is the product of the weight of an item by its arm.
MTOW	Maximum Take-off Weight
Reference Datum	Reference Datum is an imaginary vertical plane from which all horizontal distances are measured for balance purposes.
fwd	Forward, towards the propeller
aft	Towards the tail
Standard Empty Weight	Standard empty weight is the weight of a standard airplane, including unusable fuel, full operating fluids, and full engine oil.
Basic Empty Weight	Basic empty weight is the standard empty weight plus the weight of optional equipment.

1.4.6 Units of measurements

Units of measurement are SI units by default. Conversion is made to Imperial units and are provided for convenience, in *italic characters* and / or between brackets.

A	Electrical current - Amperes	
bar	Pressure - Bars	1 bar = 14.5037 psi
°C	Temperature - degrees Celsius	$^{\circ}\text{C} = (^{\circ}\text{F} - 32)/1.8$
°F	Temperature - degrees Fahrenheit	$^{\circ}\text{F} = (^{\circ}\text{C} \times 1.8) + 32$
ft	Distance - Foot or feet	1 ft = 12 in = 0.3048 m = 304.8 mm
fpm	Speed - feet per minute	1 fpm = 0.00508 m/s
gal (US)	Volume – US gal	1 US gal = 0.83 UK gal = 3.785 L
hp	Power - Horse Power	1 hp = 0.7457 kW
in	Distance - inches	1 in = 25.4 mm
kg	Mass - Kilograms	1 kg = 2.205 lb
km	Distance - Kilometres	1 km = 1000 m = 0.54 NM = 0.621 SM
km/h	Speed - kilometres per hour	1 km/h = 0.54 knots = 0.621 mph = 0.278 m/s
knot	Speed - Nautical Miles per hour	1 knot = 1.151 mph = 1.852 km/h = 0.514 m/s
kW	Power - kilo-Watts	1 kW = 1.341 hp
L	Volume - Litres	1 L = 0.264 US gal
lb	Mass - Pounds	1 lb = 0.454 kg
Lbf	Force - Pound-force	1 lbf = 4.448 N
m	Distance - Metres	1 m = 1000 mm = 3.28 ft = 39.37 in
mm	Distance - Millimetres	1 mm = 0.03937 in
mph	Airspeed - statute miles per hour	1 mph = 0.87 knots = 1.609 km/h
m/s	Vertical speed - meters per second	1 m/s = 196.8 fpm = 1.944 knots = 3.6 km/h
N	Force - Newtons	1 N = 0.225 lbf
NM	Distance - Nautical Miles	1 NM = 1852 m
psi	Pressure – pound force per square inch	1 psi = 0.0689 bar
rpm	Rotational speed - Revolution per minute	
s or sec	Time - Second	
SM	Distance - Statute Mile	1 SM = 1.609 km
V	Electrical voltage - Volt	

1.5 Aircraft description and dimensions

Elixir is a single-engine, all composite, low-wing monoplane of monocoque structure with two side-by-side seats. The airplane is equipped with a fixed tricycle undercarriage with steering nose wheel.

1.5.1 Airplane manufacturer



Aéroport de La Rochelle - Ile de Ré – LFBH
Lat : 46° 10' 45" N – Long : 001° 11' 43" W
Rue du Jura
17 000 La Rochelle - France
www.elixir-aircraft.com

1.5.2 Three view Drawings

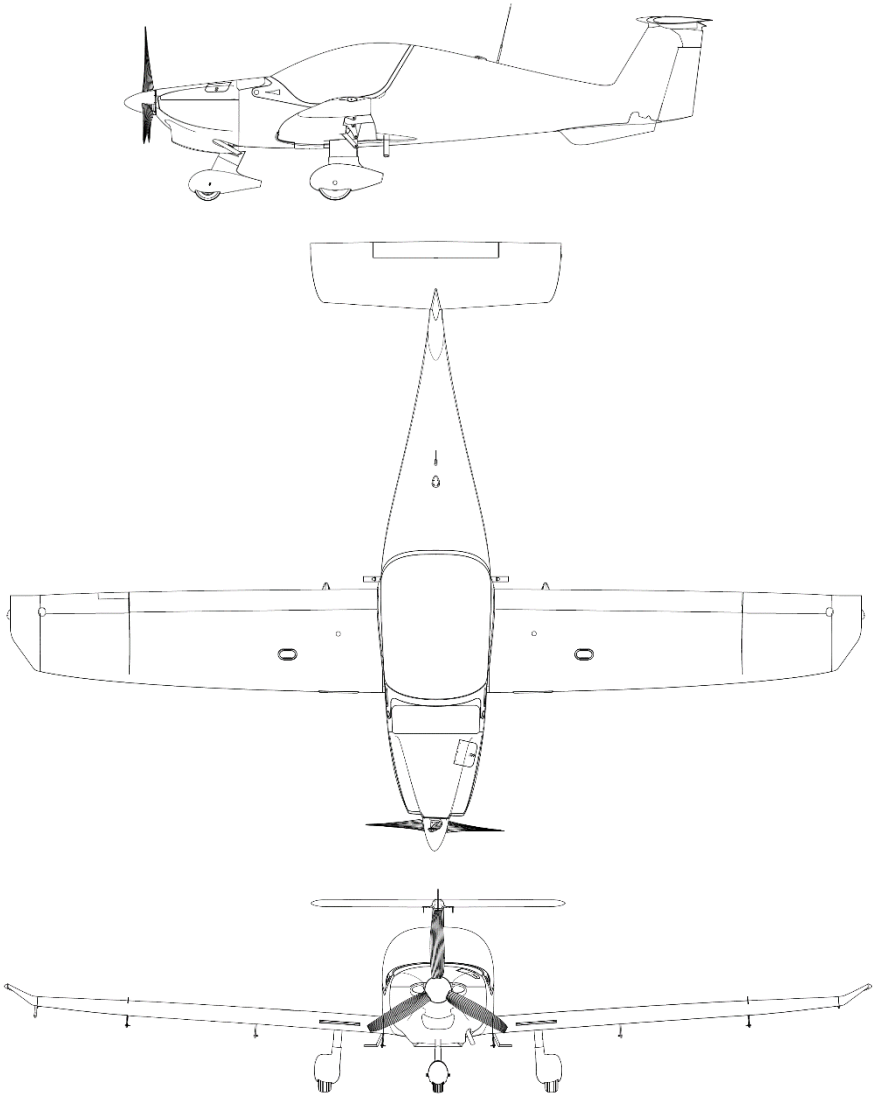

1.5.3 Main airplane dimensions, control surface deflections

	Metric	Imperial
WING		
Wing span:	8.48 m	27.82 ft
Mean Aerodynamic Chord:	0.947 m	3.107 ft
Wing surface area:	7.9 m ²	85 ft ²
Wing loading:	79.7 kg/m ²	16.3 pound/foot ²
Aspect ratio:	9.1	
Dihedral:	3.5° (measured at flap hinge line)	
FUSELAGE		
Overall length:	6.06 m	19.9 ft
Cockpit width:	1.10 m	3.61 ft
Overall height:	1.90 m	6.23 ft
EMPENNAGE		
Horizontal stabilizer span:	2.5 m	8.2 ft
Horizontal stabilizer surface area:	1.546 m ²	16.64 ft ²
Vertical stabilizer span:	1.03 m	3.34 ft
Vertical stabilizer surface area:	0.8 m ²	8.6 ft ²
Rudder surface area:	0.3 m ²	3.2 ft ²
LANDING GEAR		
Wheel track:	2.20 m	7.22 ft
Wheel base:	1.32 m	4.33 ft
CONTROL SURFACE TRAVEL LIMITS		
Ailerons:	21°(±1°) trailing edge up, 14° (±1°) down	
Aileron trim tab	17° (+3°/-0°) trailing edge up, 17° (+3°/-0°) down	
Stabilizer:	8.5° (±0.5°) trailing edge up 6.5 (±0.5°) down .	
Tab gearing ratio	1.7	
Trim tab:	Up (full nose dwn trim): 0° = aligned with elevator airfoil (±1°) Down (full nose up trim) : +17° below elevator airfoil (±1°) Measured with elevator in neutral position	
Rudder:	Must reach the built-in, non-adjustable control stops on both sides (indicative value: +/-18°)	
Flaps:	0°(-0°/+1°) Cruise 15° (±1°) Take Off 37° (+0°/-1°) Landing	

Intentionally left blank

2 Limitations

2.1	Introduction	2-2
2.2	Airspeed.....	2-2
2.3	Airspeed Indicator Markings	2-3
2.4	Engine	2-3
2.4.1	Engine limits	2-3
2.4.2	Oil pressure and temperature	2-3
2.4.3	Coolant temperature.....	2-4
2.4.4	Fuel pressure and temperature.....	2-4
2.4.5	OAT for engine start and operation.....	2-4
2.5	Propeller	2-4
2.6	Engine instruments markings	2-5
2.7	Weight	2-6
2.8	Centre of Gravity.....	2-6
2.9	Manoeuvring load factor.....	2-7
2.10	Flight Crew.....	2-7
2.11	Kind of operations	2-7
2.12	Fuel.....	2-8
2.12.1	Quantities	2-8
2.12.2	Approved Fuel Grades.....	2-8
2.12.3	Tank filling precautions	2-8
2.13	Oil	2-9
2.13.1	Quantities	2-9
2.13.2	Approved Oil Grades :	2-9
2.14	Engine coolant	2-9
2.14.1	Quantities	2-9
2.14.2	Approved Coolant specifications :	2-9
2.15	Systems & Equipment.....	2-10

2.15.1	Garmin G3X Touch.....	2-10
2.15.2	Transponder GTX335R	2-10
2.15.3	Ballistic recovery parachute	2-10
2.16	Other limitations	2-10
2.17	Minimum instruments and equipment list.....	2-11
2.17.1	for day VFR flights	2-11
2.17.2	for night VFR flights	2-11
2.18	Limitation placards	2-12

2.1 Introduction

The aeroplane must be operated in accordance with the limitations provided below.

2.2 Airspeed

IAS = CAS + 2 km/h (+1.1 kts) in any aircraft configuration over the whole flight envelope.

Note

In case of inconsistency, the indication provided by the analogue (E)TSO certified anemometer prevails.

Speed	km/h		knots		Remarks
	CAS	IAS	CAS	IAS	
Never Exceed Speed V_{NE}	288	290	155	156	Do not exceed this speed in any operation.
Maximum Structural Cruising Speed V_{NO}	242	244	130	131	Do not exceed this speed except in smooth air and then only with caution.
Manoeuvring Speed V_A	222	224	120	121	Do not make full or abrupt control movements above this speed. Limit load factor may be exceeded
Maximum Flap Extended Speed V_{FE}	162	164	87	88	(Flaps T/O / LDG) Do not exceed this speed with flaps extended

2.3 Airspeed Indicator Markings

Marking	IAS km/h	IAS kts	Significance
White arc	85 – 164	46 - 88	<i>Positive Flap Operating Range.</i> (Lower limit is maximum weight V_{SO} in landing configuration. Upper limit is maximum speed permissible with flaps extended positive.)
Green arc	113 - 244	60 - 131	<i>Normal Operating Range.</i> Lower limit is maximum weight VS1 at most forward c.g. with flaps retracted. Upper limit is maximum structural cruising speed.
Yellow arc	244 – 290	131 - 156	Manoeuvres must be conducted with caution and only in smooth air.
Red line	290	156	Maximum speed for all operations
Yellow line	224	121	Manoeuvring speed V_a

The analog ETSO instrument and the G3X must be marked, both in the same unit.

2.4 Engine

Engine Manufacturer.....
Engine Model Number.....

BRP-Rotax GmbH & Co KG
Rotax 912 iSc3 Sport

2.4.1 Engine limits

Take-off Power	<i>73.5 kW (100 HP) at 5800 RPM (max 5 min)</i>
Maximum Continuous Power	<i>72 kW (97.9 HP) at 5500 RPM</i>
Max engine RPM	<i>Take off: 5800 RPM for max 5 minutes Continuous: 5500 RPM</i>
Minimum idle speed	<i>1400 RPM</i>
Exhaust gas temperature	<i>Max 950°C (1742°F)</i>

2.4.2 Oil pressure and temperature

Pressure	
Minimum.....	<i>0.8 bar (12 psi) <3500 RPM</i>
Maximum.....	<i>7 bar - 101 psi admissible for a short period at cold start</i>
Normal.....	<i>2 to 5 bar – 29 to 72 psi</i>

Temperature	
Minimum.....	50°C (120°F)
Maximum.....	130°C (266°F)
Normal.....	Approx. 90 to 110°C (190 to 230 °F)

2.4.3 Coolant temperature

Maximum temperature.....	118°C (245°F)
--------------------------	----------------

2.4.4 Fuel pressure and temperature

Pressure	
Minimum.....	2.5 bar (36 psi)
Maximum.....	3.8 bar (55 psi)

2.4.5 OAT for engine start and operation

Maximum	50 °C (122°F)
Minimum	-20 °C (-4°F) (at engine start : oil temperature)

2.5 Propeller

Propeller Manufacturer.....	MT-propeller
Propeller Model Number.....	MTV-34-1-A/156-203
Propeller Diameter.....	1,560 m (61.4 in)

Mandatory settings:

Governor max RPM (in flight)	5800 rpm +0/-50 rpm
Hub fine pitch stop setting for ground run at full Throttle (ISA, no wind)	5400 rpm ±50 rpm

2.6 Engine instruments markings

Instrument	Dial range	Red	Yellow arc	Green arc	Yellow arc	Red
		MINIMUM LIMIT	CAUTION RANGE	NORMAL OPERATING	CAUTION RANGE	MAXIMUM LIMIT
TACHOMETER	0-6000 RPM		1400-2000 RPM	2000-5500 RPM	5510-5800 RPM	5800 RPM
MANIFOLD PRESSURE	0-32 in.Hg			10-30 in.hg		
EXHAUST GAS TEMP.	500-1100 °C 932-2012°F			500-900°C 932-1652°F	900-950 °C 1652-1742°F	>950°C >1742°F
OIL TEMP.	40-140 °C 104-284°F		40-50°C 104-122°F	50-110°C 122-230°F	110-130°C 230-266°F	>130°C >266°F
OIL PRESSURE	0-8 bar 0-145 PSI	<0.8 bar <11 PSI	0.8-2 bar 11-29 PSI	2-5 bar 29-72 PSI	5-7 bar 72-101 PSI	>7 bar >101 PSI
COOLANT TEMP.	40-140 °C 104-284°F		40-50°C 104-122°F	50-110°C 122-230°F	110-118°C 230-244°F	>118°C >244°F
FUEL PRESSURE	0-5 bar 0-72 PSI	<2.5 bar <36 PSI	2.5-2.8 bar 36-41 PSI	2.8-3.2 bar 41-46 PSI	3.2-3.8 bar 46-55 PSI	>3.8 bar >55 PSI
Essential Bus Voltage "Volts 1"	8-16 V	<12.5 V	12.5-13.4 V	13.4-14.6V	14.6-15.2 V	>15.2 V
Engine ECU Bus B voltage "Volts B"	8-16 V	<9V	9-12V	12-15V		>15V
Battery Current "AMPS"	-10/+40 A	< -3 A	-3 / 0 A	0 / 28 A	28 / 30 A	>30 A
FUEL QTY	0-100L 0-26.4 gal		0-5 L 0-1.3 gal	5-100 L 1.3-26.4 gal		
AIRFRAME °C	-20/+100°C -4/+212°F			-20°C- 54°C -4°F-130°F	54°C-100°C 130°F-212°F	

2.7 Weight

Maximum take-off weight..... 630 kg (1389 lbs)
 Maximum landing weight..... 630 kg (1389 lbs)
 Maximum weight in baggage compartment.. 25 kg (55 lbs),
 properly secured

2.8 Centre of Gravity

Max fwd at 500 kg (1102 lbs)	Max fwd at 630 kg (1389 lbs)	Max aft at 630 kg (1389 lbs)
720 mm (28.35 in) from firewall	800 mm (31.50 in) from firewall	860 mm (33.87 in) from firewall

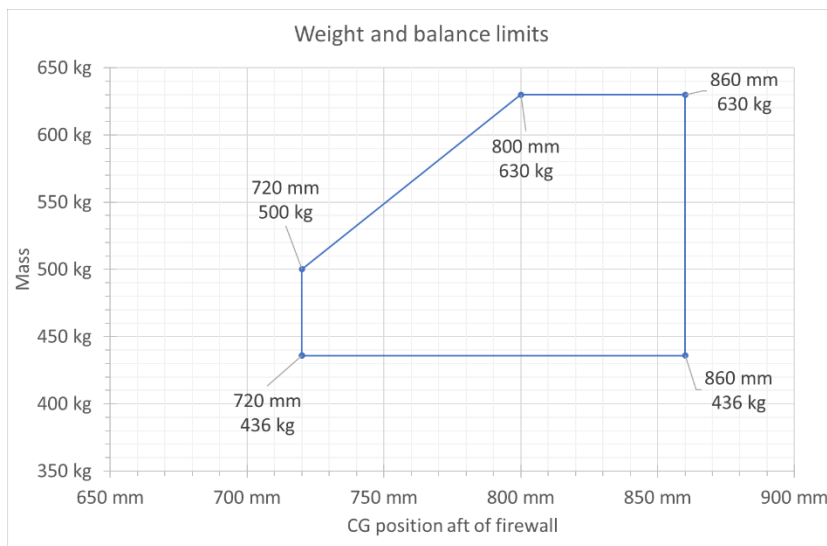

Conversion chart	distance	mm	720	800	860
		in	28.35	31.50	33.86
	mass	kg	436	500	630
		lbs	961	1102	1389

2.9 Manoeuvring load factor

Maximum positive limit load factor.....	+ 4 g
Maximum negative limit load factor.....	- 2 g
Maximum positive limit load factor with flap extended....	+2 g
Maximum negative limit load factor with flaps extended..	0 g

Caution

Engine limitation

Negative load factor manoeuvres limited to -0.5g for max 5 seconds - refer to engine operators manual

2.10 Flight Crew

Number of seats	2
Minimum crew	1

2.11 Kind of operations

The aircraft is approved for day and night VFR operation only, away from thunderstorm clouds.

WARNING

IFR flights, aerobatic manoeuvres and intentional spins are prohibited.

Avoid flying in the vicinity of thunderstorm clouds

Avoid icing conditions

2.12 Fuel

2.12.1 Quantities

Total fuel quantity.....	104 L - 27.5 gal
Unusable fuel.....	4 L - 1.05 gal
Total usable fuel.....	100 L – 26.4 gal

2.12.2 Approved Fuel Grades

Engine and aircraft components are compatible with:

- Unleaded Mogas 95/98 / E5 (not approved for flights above FL120)
- Unleaded AVGAS UL91 / UL 94
- AVGAS 100 LL (with limitations with regards to engine maintenance)

WARNING

Fuels containing more than 5% ethanol/methanol (E10, E85) are not approved

Caution

AVGAS 100LL places greater stress on the valve seats due to its high lead content and forms increased deposits in the combustion chamber and lead sediment in the oil system. Check latest Rotax Maintenance Manual for specific maintenance instructions.

2.12.3 Tank filling precautions

Ground the aircraft via the exhaust pipe, when filling the tank at a pump in order to electrically discharge the aircraft and not to create an electric arc between the pistol and the cap.

Please refer to § 7.10.2 for detailed fuelling instructions.

2.13 Oil

2.13.1 Quantities

Oil volume: about 3.5 L (0.9 gal)

minimum Lower mark of oil dipstick.

maximum Upper mark of oil dipstick.

See pre-flight check procedures for oil level check

Note

Oil quantity from min to max level: 0.45 L (0.1 gal)

WARNING

The oil level should be in the upper half and should never fall below the “min” mark. Prior to long flights oil should be added so that the oil level reaches the “max” mark.

FLAMMABLE FLUID : Always clean oil spilled in the engine compartment before flight.

2.13.2 Approved Oil Grades :

Obey the latest edition of Rotax service instruction SI-912 i-001 to select the correct oil. AeroShell Oil Sport Plus 4 recommended.

2.14 Engine coolant

2.14.1 Quantities

Coolant Volume: about 2.5 L. (0.66 gal)

Expansion tank must be full, level in Overflow bottle between “min” and “max” (cold engine).

2.14.2 Approved Coolant specifications :

Only 50%-50% Water / Ethylene-Glycol mix authorised.

Coolants to Volkswagen specifications -30°C G12, G12+, G12++, G13 are a suitable example.

Refer to the latest edition of Rotax service instruction SI-912 i-001 for recommended 50%-50% Water-Ethylene-Glycol brand. (in case of doubt, contact Elixir Aircraft).

WARNING

Waterless coolant is not allowed. Coolants with less than 40% or more than 60% ethylene glycol are not allowed. Potentially **FLAMMABLE FLUID** : Always clean coolant spilled in the engine compartment before flight.

2.15 Systems & Equipment

2.15.1 Garmin G3X Touch

The Garmin G3X Touch GPS is not a class A navigation aid, it is provided for information purposes only. Only use in VMC with ground or sea in sight. Do NOT use the Garmin G3X Touch as a primary source for navigation, terrain separation, weather information, or approach information.

For safety reasons, G3X Touch operational procedures must be learned on the ground.

WARNING

Changing the G3X setup made by the manufacturer is prohibited to pilot's / owners and unauthorised maintenance personnel. If you think you have inadvertently entered in the configuration pages seek advice from Elixir Aircraft.

2.15.2 Transponder GTX335R

The transponder GTX335R, as equipped on the Elixir, is not capable of ADSB-OUT (it is not connected to any certified GPS source). ADSB OUT function is deactivated.

The transponder installation is certified for Mode S ELS (Elementary Surveillance) and Mode S EHS (Enhanced Surveillance) in accordance with CS-ACNS book 1 subpart D section 2 and 3.

2.15.3 Ballistic recovery parachute

The ballistic recovery parachute must be installed, and in airworthy condition (canopy repacking, rocket replacement time limits: see aircraft maintenance manual). The aeroplane is not airworthy if the parachute is removed or not serviced in due time. A one-way ferry flight to a maintenance facility can be permitted. (However, do not hesitate to attempt to use the parachute even if it is out of date, should this happen).

2.16 Other limitations

Primary airframe structure temperature

The aeroplane must not be flown if the primary structure temperature is above 54°C.

For any primary structure surfaces directly exposed to sunlight, the pilot must check that the primary structure is cool enough before take-off. A temperature sensor is installed on the critical part of the structure and displayed on the G3X as "AIRFRAME °C". If the airframe temperature raises above 54°C, a MASTER CAUTION is raised on the annunciator panel and the CAS Message "Airframe Tem" is displayed. Do not take off until temperature has cooled down below 54°C.

Service ceiling: Flight Level 160.

(Altitude limited to FL120 when using Unleaded Mogas 95/98 / E5 fuel)

Outside Air Temperature: > -20°C / -4°F

Starting attempts: Activate the starter for 10 sec max. only without interruption, followed by a cooling time of 2 min. Do not operate the starter if the engine is running.

SMOKING IS PROHIBITED

2.17 Minimum instruments and equipment list

2.17.1 for day VFR flights

- 1 airspeed indicator
- 1 sensitive barometric altimeter
- 1 magnetic compass
- 1 fuel low level indicator
- 1 oil temperature indicator
- 1 oil pressure indicator
- 1 coolant temperature indicator
- 1 engine rpm indicator
- 1 manifold pressure
- Seat belts for every used seat
- 1 airframe temperature sensor

2.17.2 for night VFR flights

- 1 backlighted airspeed indicator
- 1 backlighted sensitive barometric altimeter
- 1 backlighted magnetic compass
- 1 fuel low level indicator
- 1 oil temperature indicator
- 1 oil pressure indicator
- 1 coolant temperature indicator
- 1 engine rpm indicator
- 1 manifold pressure
- Seat belts for every used seat
- 1 airframe temperature sensor
- 3 backlit instrument labels
- 1 shut-off valve lighting LED
- 1 RH glare shield removable extension
- 1 LH glare shield removable extension
- 1 personal headlamp

2.18 Limitation placards

This section provides limitation and information placards, and their location on the aircraft.
 Remark: For further placards refer to Maintenance Manual.

This aeroplane is approved for day and night VFR only, in non-icing conditions. All aerobatic manoeuvres including intentional spinning are prohibited. See Flight Manual for other limitations. Airframe Temp < 54°C Manoeuvring speed: $V_A = 224 \text{ km/h} - 121\text{kts IAS}$

instrument panel.

MAX BAGGAGE WEIGHT: 25 kg / 55 lbs
Properly secured

..... rear luggage bulkhead

COOLANT	
	TYPE WATER / ETHYLENE GLYCOL MIX 50/50
QTY APPROX 2.5L	EXPANSION TANK MUST BE FULL LEVEL IN OVERFLOW BOTTLE BETWEEN MIN AND MAX. READ ROTAX SERVICE INFORMATION SI-912-1-00L LATEST EDITION AND ELIXIR FLIGHT MANUAL.
OIL	
	TYPE AeroShell Sport Plus 4 RECOMMENDED. READ ROTAX SERVICE INFORMATION SI-912-1-00L LATEST EDITION AND ELIXIR FLIGHT MANUAL.

under the engine cowling hatch



..... luggage bulkhead

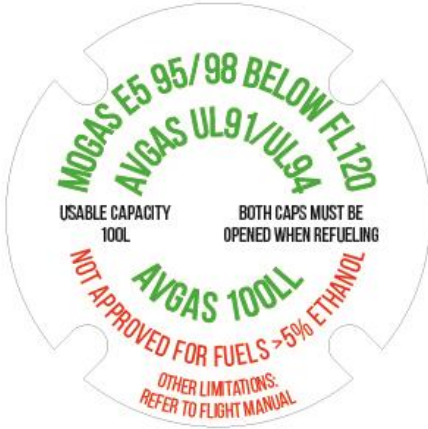

..... next to both fuel caps

NO PUSH

.....both wingtips, aileron trim tab, elevator tab



.....wing trailing edge



.....flap vane



.....main flap

BRS™ WHOLE AIRCRAFT RESCUE PARACHUTE SYSTEM	
<i>Model: ELDXSP-05, Elixir Aircraft Softpack</i>	
BALLISTIC RECOVERY SYSTEMS, INC. 300 Airport Road South St. Paul, MN 55075 USA Phone: (651) 457-7491 Fax: (651) 457-8651 www.brs aerospace.com	WARNING: AIRCRAFT GROSS WEIGHT UP TO 13884.1 LB (615 kg) AND DEPLOYMENT SPEED UP TO 175 KIAS (99-mph) TRUE AIRSPEED. EXCEEDING THESE LIMITATIONS, OR USING IMPROPER INSTALLATION, MAY CAUSE DEPLOYMENT FAILURE AND DEATH OR SERIOUS INJURY TO OCCUPANTS. SERVICE & REPAIR BY BRS ONLY.
	NEVER POINT CHUTE DISCHARGE TOWARD ANYONE AT ANY TIME - ACCIDENTAL DISCHARGE CAN CAUSE DEATH OR SERIOUS INJURY. TREAT LIKE A LOADED GUN.

.....on the parachute bag



..... on top of the parachute rocket

..... on the parachute egress panel

.....both sides of the fuselage

TIRE PRESSURE
bar 2.5 (+/- 0.1)
psi 36 (+/-2)

..... nose wheel

TIRE PRESSURE
bar 2.1 (+/- 0.1)
psi 31 (+/-2)

..... main wheels



..... fin trailing edge cover and control stick fixations

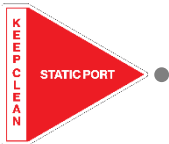

or



.....static ports (both sides)



..... right luggage bulkhead

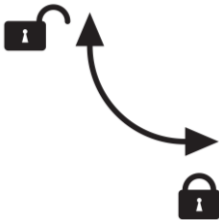

.....next to the handle inside the canopy



.....Identification Plate, engraved stainless steel, 5x10 cm, rivetted on rear bulkhead (example)

3 Emergency Procedures

3.1	Introduction	3-4
3.2	Recommended airspeeds in emergencies.....	3-5
3.3	Engine failures	3-6
3.3.1	Engine failure during take-off run.....	3-6
3.3.2	Loss of engine power in flight	3-6
3.3.3	Powerplant vibrations	3-7
3.3.4	Single Lever Power Control malfunction	3-8
3.4	Engine restart in flight	3-10
3.4.1	Propeller windmilling.....	3-10
3.4.2	Propeller stopped	3-10
3.5	Smoke and fire (Engine).....	3-11
3.5.1	On ground	3-11
3.5.2	In flight	3-11
3.6	Smoke and fire (Cabin / Electrical)	3-13
3.6.1	On ground	3-13
3.6.2	In flight	3-13
3.7	Glide	3-14
3.8	EMERGENCY LANDING	3-15
3.9	Spin recovery	3-16
3.10	Loss of primary flight controls.....	3-16
3.10.1	Elevator	3-16
3.10.2	Aileron	3-16
3.10.3	Rudder	3-16
3.11	Trim runaway (elevator and/or ailerons)	3-17
3.12	Flaps runaway.....	3-18
3.12.1	Unwanted flap deployment	3-18
3.12.2	Unwanted flap retraction.....	3-18

3.13	Inadvertent canopy opening during take off	3-19
3.13.1	During the take off run	3-19
3.13.2	Airborne	3-19
3.14	Warnings Lights	3-20
3.14.1	MASTER WARN (red warning light)	3-20
3.14.2	MASTER CAUTION (amber caution light)	3-26
3.14.3	ONE LANE (A or B) FLASHING (amber caution light)	3-31
3.14.4	BOTH LANES (A and B) FLASHING (amber caution light x2)	3-31
3.14.5	ONE LANE (A or B) STEADY ON (amber caution light)	3-31
3.14.6	BOTH LANES (A and B) STEADY ON (amber caution lights x2)	3-32
3.14.7	FUEL LEVEL (amber caution light)	3-32
3.14.8	FLAP DEFAULT (amber caution light)	3-32
3.14.9	BATTERY DEFAULT (amber caution light)	3-33
3.14.10	EMGCY PWR (amber caution light)	3-33
3.14.11	START PWR (blue status light)	3-33
3.15	Charge/OV circuit breaker popped-out	3-34
3.16	GENERATOR FAULT procedures	3-35
3.16.1	EMGY switched OFF	3-35
3.16.2	EMGY switched ON	3-35
3.17	Ballistic rescue system activation	3-36
3.18	Abnormal procedure: Transponder management in case of G3X failure	3-37
3.19	G3X failures and annunciation	3-37
3.19.1	ADC FAIL	3-37
3.19.2	MESSAGE	3-37
3.19.3	ATTITUDE FAIL	3-37
3.19.4	AHRs ALIGN	3-38
3.19.5	ALIGNING KEEP WINGS LEVEL	3-38
3.19.6	EIS failure	3-38
3.19.7	G3X Touch Failure Annunciations	3-39

3.19.8	Heading failure, loss of magnetometer data, magnetic field error.	3-39
3.19.9	PFD failure	3-39
3.19.10	Navigation data failure	3-40
3.20	External and cockpit lighting failures (at night).....	3-40
3.20.1	LDG light failure.....	3-40
3.20.2	NAV and/or FLASH light failure.....	3-40
3.20.3	Instrument backlight failure	3-41
3.20.4	Map light failure	3-41
3.20.5	Terrain and obstacle annunciations	3-42

3.1 Introduction

This section describes operations and procedures for emergency situations that could possibly occur during airplane operation.

Emergencies caused by aircraft or engine malfunction are extremely rare if proper pre-flight inspections and maintenance are practiced.

However, should an emergency arise, the basic guidelines described in this section should be considered and applied as necessary to correct the problem.

In case of emergency the pilot should remember the following priorities –

- 1 FLY the aircraft,**
- 2 IDENTIFY the problem,**
- 3 Apply applicable PROCEDURES,**
- 4 REPORT situation, time and conditions permitting.**

Note

in the following, the instructions to “Perform an EMERGENCY LANDING”, “land AS SOON AS POSSIBLE” or “Land At the Nearest Suitable Airfield” have the following meanings

- Perform EMERGENCY LANDING: you are in a critical situation ! Land on the nearest reasonably large and smooth surface. Damage may occur on the aircraft.

- Land AS SOON AS POSSIBLE: you are in a situation that may become critical in the short term. Direct to the closest airfield and land immediately, declare emergency to air traffic control. This does not mean to land in a field.

- Land At the Nearest Suitable Airfield: you are not in a critical situation. Choose the nearest airfield where you would find local support, follow standard procedures and follow air traffic control instructions. Keep monitoring parameters with care.

3.2 Recommended airspeeds in emergencies

Note

the IAS indication provided by the analogue (E)TSO certified anemometer prevails.

Best glide	140 km/h – 76 kts Flaps UP. Glide ratio is approx. 10:1
Engine failure after take-off minimum speed	130 km/h – 70 kts Flaps T/O
Precautionary landing with engine power	110 km/h – 60 kts Flaps LDG
EMERGENCY LANDING without engine power	110 km/h – 60 kts Flaps LDG

3.3 Engine failures

3.3.1 Engine failure during take-off run

1.	Throttle	<i>IDLE</i>
2.	Brakes	<i>Apply as required</i>
When controlled:		
3.	FUEL shut-off valve	<i>OFF</i>
4.	Engine Key Switch StartAssist	<i>OFF</i>
5.	MASTER Switch	<i>OFF</i>

3.3.2 Loss of engine power in flight

3.3.2.1 If level flight remains possible

1.	AIRSPEED	<i>minimum 140 km/h / 76 kts for level flight with flap up</i>
2.	Fuel Shut-off valve	<i>Check OPEN</i>
3.	Engine Key Switch StartAssist	<i>Check RUN</i>
4.	LANE switch	<i>Check BOTH / select best option</i>
5.	Throttle	<i>Position for adequate power</i>
6.	Land	<i>AS SOON AS POSSIBLE</i>

Caution

Be prepared for a complete engine failure and an **EMERGENCY LANDING**

3.3.2.2 Complete engine failure, or level flight not possible

1.	Maintain a safe AIRSPEED (best glide = 140 km/h – 76 kts)	
2.	Fuel Shut-off valve	<i>Check OPEN</i>
3.	Engine Key Switch StartAssist	<i>Check RUN</i>
4.	Search a suitable landing site and prepare for an EMERGENCY LANDING .	
5.	Engine restart procedure	<i>Apply (§3.4)</i>

3.3.3 Powerplant vibrations

1.	Engine Key Switch StartAssist	<i>Check RUN</i>
2.	LANE Switch	<i>Check BOTH / select best option</i>
3.	Land	AS SOON AS POSSIBLE

If deterrent vibrations

1.	Engine Key Switch StartAssist	<i>OFF</i>
2.	Search a suitable landing site and prepare for an EMERGENCY LANDING	

3.3.4 Single Lever Power Control malfunction

3.3.4.1 RPM oscillations (propeller governor anomaly)

1.	Throttle	<i>Try a slightly different throttle position</i>
If no effect		
2.	GVNR Switch	Disengage
3.	GVNR Switch	Re-engage once
If oscillations re-appear		
4.	GVNR Switch	Disengage
5.	Throttle	Adjust throttle to maintain safe flight conditions.

Caution

Anticipate reduced climb rate on takeoff or go around. Elixir Aircraft demonstrated 7% minimum positive climb angle at 4700rpm, max weight, sea level, in all flaps configuration with full throttle.

Note

The GVNOR Governor Disconnect Switch is protected against inadvertent operation.
 Pull then press down to switch OFF
 Pull then press up to switch ON

Note

when the GVNR Switch is OFF, the signal to the propeller governor is disconnected. The RPM will slowly decrease until reaching the governor minimum RPM mechanical stop, regardless of engine parameter or throttle position variations.

In any case, the governor mechanical stops are adjusted so that the engine speed command is mechanically contained between 4700rpm and 5800rpm.

Therefore, regardless of RPM management system behaviour, the aircraft is always protected against:

- Engine overspeed
- Powerplant underpower / overtorque

3.3.4.2 *RPM remains constant or slowly decreases regardless of throttle inputs*

Possible cause :

Failure of the propeller governor electric actuator

1.	GVNR Switch	Check ON
If no effect		
2.	Throttle	Adjust throttle to maintain safe flight conditions.

Caution

Anticipate reduced climb rate on takeoff or go around. Elixir Aircraft demonstrated 7% minimum positive climb angle at 4700rpm, max weight, sea level, in all flaps configuration with full throttle

Note

when the propeller governor servomotor is disconnected, the RPM will slowly decrease until reaching the governor minimum RPM mechanical stop, regardless of engine parameter or throttle position variations.

In any case, the governor mechanical stops are adjusted so that the engine speed command is mechanically contained between 4700rpm and 5800rpm.

Therefore, regardless of RPM management system behaviour, the aircraft is always protected against:

- Engine overspeed
- Powerplant underpower / overtorque

3.4 Engine restart in flight

3.4.1 Propeller windmilling

1.	Maintain a safe airspeed and monitor height above ground	
2.	MASTER Switch	Check ON
3.	Throttle position	Approx. 50%
4.	FUEL shut-off valve	Check OPEN
5.	EMGY switch	Switch ON
6.	Engine Key Switch StartAssist	Check RUN
If engine restarts		
7.	EMGY switch	Switch OFF
If engine tends to fail again		
8.	EMGY switch	Switch ON IMMEDIATELY
9.	GENERATOR FAULT procedure	Apply (§3.16)
If engine does not restart		
10.	Engine Key Switch StartAssist	OFF
11.	EMERGENCY LANDING	
		Prepare

3.4.2 Propeller stopped

Same procedure as above, except:

6.	Engine Key Switch StartAssist	START then RUN after engine restart
----	--------------------------------------	--

Note

In case of an engine failure (without engine seizure), the propeller stops when airspeed falls below approx. 110 km/h – 60 kts. The aircraft's speed must be increased above approx. 200 km/h – 108 kts to obtain the propeller rotation.

3.5 Smoke and fire (Engine)

3.5.1 On ground

STOP the aircraft		
1.	FUEL shut-off valve	OFF
2.	Throttle	MAX
After engine stops		
3.	Engine Key Switch StartAssist	OFF
4.	MASTER Switch	OFF
5.	CABIN HEATER	OFF
Leave the aircraft		

Note

if a fire extinguisher is available, it can be discharged in the LH upper air intake or cowl exhaust openings

3.5.2 In flight

1.	FUEL shut-off valve	OFF
2.	Engine Key Switch StartAssist	OFF
3.	Throttle	IDLE
4.	CABIN HEATER	OFF
5.	Cabin Ventilation	Close if smoke entering through ventilation outlet- Open if no smoke entering through outlet and smoke evacuation needed
6.	EMERGENCY LANDING	prepare

WARNING

Never attempt an engine restart

Caution

using the BRS in case of fire may not be the safest solution. Fire could propagate to the parachute suspension bridles or to the parachute itself during descent.

If absolutely no safe landing area is available:

- perform an emergency descent
- level the aircraft at +/-1500 ft above surface and slow down to 120 km/h – 65 kts
- fire the BRS (§3.17)

3.6 Smoke and fire (Cabin / Electrical)

3.6.1 On ground

Stop the aircraft		
1.	MASTER Switch	OFF
2.	Engine Key Switch StartAssist	OFF
3.	FUEL shut off valve	OFF
4.	Canopy	OPEN

Note

if a fire extinguisher is available, it can be discharged on the burning equipment if identified

3.6.2 In flight

If equipment identified

1.	Faulty equipment	Switch OFF
2.	Ventilation	OPEN
3.	Fire extinguisher	Use if absolutely needed
4.	Land	AS SOON AS POSSIBLE

If equipment not identified

5.	MASTER Switch	OFF
6.	Ventilation	OPEN
7.	Fire Extinguisher	Use if absolutely needed
8.	Land	AS SOON AS POSSIBLE

All electrical equipment are lost (including flaps and trims).

Reduced flaps landing: increase approach speed :

Flaps UP: IAS = 140 km/h – 76 kts

Flaps T/O: IAS = 125 km/h – 68 kts

Note

Normal engine operation

3.7 Glide

Wing flaps position	UP (0°)
Airspeed	140 km/h – 76 kts
Glide Ratio	10:1

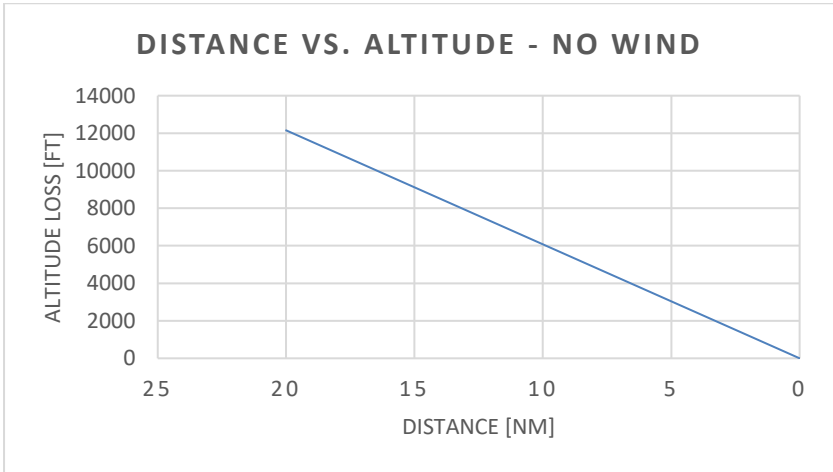

3.8 EMERGENCY LANDING

Descent

1.	AIRSPPEED	<i>maintain 140 km/h - 76 kts with flaps UP</i>
2.	Emergency landing area	<i>Select a suitable area. Determine wind direction.</i>
3.	Seat belts...	<i>Fasten, tighten</i>
4.	Flaps	<i>as required- adjust speed</i>
<i>Time permitting:</i>		
5.	VHF	<i>Apply standard emergency procedures</i>
6.	XPDR	<i>Apply standard emergency procedures</i>
7.	ELT	<i>ON</i>

On final

8.	Flaps	<i>LDG (when landing site secured)</i>
9.	LDG Lights	<i>ON for Night VFR flight</i>
10.	Airspeed	<i>110 km/h – 60 kts</i>

Just before touch-down

11.	FUEL shut-off valve	<i>OFF</i>
12.	Engine Key Switch StartAssist	<i>OFF</i>
13.	MASTER Switch	<i>OFF</i>
14.	EMGY switch	<i>OFF (if switched ON)</i>

After touch down

15.	Elevator	<i>Keep pulling aft</i>
-----	----------	-------------------------

WARNING

Do not unlock the canopy before touch down. The forward hinged canopy would partially open and may perturb airflow on the T-tail.

3.9 Spin recovery

WARNING

Intentional spins are prohibited

No extensive spin tests were performed during certification.

The following generic spin recovery procedure should be applied:

1.	<u>Simultaneous</u>	Rudder	<i>FULL OPPOSITE to the rotation side</i>
		Elevator	<i>Neutral / Forward</i>
2.	Ailerons	<i>Neutral</i>	
3.	Throttle	<i>Idle</i>	
4.	Flaps (if extended)	<i>UP (0°)</i>	

After rotation stops

5.	Rudder	<i>neutral</i>
6.	Elevator	<i>Pull up gently (avoid a secondary stall)</i>

3.10 Loss of primary flight controls

In the unlikely event of one of the primary flight control systems failure, apply the following emergency procedures :

3.10.1 Elevator

Control the aircraft pitch attitude and speed with the elevator trim. Anticipate your actions and expect some latency.

Make a standard approach and landing. At forward CG use preferably T/O flaps position for landing as trim authority will be increased.

Avoid large bank angles and steep approaches, avoid sudden power variations.

3.10.2 Aileron

Control the bank angle with appropriate rudder inputs. Avoid large sideslips (< 1 ball). In addition, use the aileron trim. Anticipate your actions and expect some latency.

3.10.3 Rudder

When possible avoid airfields with strong crosswind for landing.

3.11 Trim runaway (elevator and/or ailerons)

1.	TRIMS circuit breaker	<i>PULL out</i>
2.	Airspeed	<i>Reduce speed as practical to reduce pilot forces on stick.</i>
3.	Land	<i>AS SOON AS POSSIBLE</i>

Caution

Both elevator and aileron trims are lost.

Note

The aeroplane remains controllable.

3.12 Flaps runaway

3.12.1 Unwanted flap deployment

1.	FLAPS circuit breaker	<i>PULL out</i>
<i>If speed above Vfe</i>		
2.	Throttle	<i>Reduce to IDLE</i>
3.	Elevator	<i>PULL smoothly to reduce speed. Avoid high G-loads.</i>
4.	Airspeed	<i>Maintain < Vfe</i>
<i>If / When speed below Vfe</i>		
5.	Airspeed	<i>Maintain below Vfe</i>
6.	Land	<i>At Nearest Suitable Airfield</i>

Look outside to visually evaluate actual flap position, and adapt approach speed :

- Flaps between UP and T/O: IAS = 140 km/h – 76 kts | Landing run increased by approx. 100 m – 328 ft
- Flaps between T/O and LDG: IAS = 125 km/h – 68 kts
- Flaps at LDG : IAS = 110km/h – 60 kts

3.12.2 Unwanted flap retraction

3.12.2.1 During take-off

1.	AIRSPEED	<i>Min 130 km/h – 70 kts</i>
2.	FLAPS circuit breaker	<i>PULL out</i>
3.	Airspeed	<i>Maintain below Vfe</i>
4.	Climb	<i>Continue climb to safe altitude</i>
5.	Return for landing	<i>Standard approach pattern</i>

Look outside to visually evaluate actual flap position, and adapt approach speed :

- Flaps between UP and T/O: IAS = 140 km/h – 76 kts | Landing run increased by approx. 100 m – 328 ft
- Flaps between T/O and LDG: IAS = 125 km/h – 68 kts

3.12.2.2 During approach

1.	GO AROUND	
2.	Throttle	<i>FULL forward</i>
3.	AIRSPEED	<i>Min 130 km/h – 70 kts</i>
4.	FLAPS circuit breaker	<i>PULL out</i>
5.	Climb	<i>To a safe altitude</i>
6.	Return for landing	<i>Standard approach pattern</i>

Look out to visually evaluate actual flap position, and adapt approach speed :

- Flaps between UP and T/O: IAS = 140 km/h – 76 kts | Landing run increased by approx. 100 m – 328 ft
- Flaps between T/O and LDG: IAS = 125 km/h – 68 kts

3.13 Inadvertent canopy opening during take off

3.13.1 During the take off run

Abort Take-Off

1.	Throttle	<i>IDLE</i>
2.	Brakes	<i>Apply as required</i>

3.13.2 Airborne

Continue the take-off

Do not try to close the canopy

1.	Airspeed	<i>max. 130 km/h – 70 kts</i>
2.	Flaps	<i>Leave initially in T/O position</i>
3.	Return for landing	
4.	Standard landing procedure	<i>Increase landing speed +10km/h – 5 kts</i>

WARNING

Priority is to maintain airplane controllability.

Caution

The canopy may be partially open and may generate turbulence on the T-Tail. Keep enough speed and perform a "flat" final approach to limit the elevator deflection needed for flare

In flight avoid side slips

After landing, inspect the canopy hinges and locking mechanism.

3.14 Warnings Lights

The following warning lights can be displayed on the annunciator panel.

3.14.1 MASTER WARN (red warning light)

Cause:

A warning message is displayed on MFD.
WARNING (red): Requires immediate attention.

Procedure:

Check MFD for warning message (displayed in red letters on a black background).
There may be several warnings displayed.
Apply corresponding procedure (see below).

WARNING list:

RPM	VOLT 1
OIL TEMP	VOLTS B
WATER TEMP	ENGINE ECU
OIL PRESS	AMPS
FUEL PRESS	EGT

3.14.1.1 Red Warning Message « RPM »

Cause:

Engine revs exceed 5800 RPM

Procedure:

1.	Throttle	<i>Reduce to minimum for safe flight</i>
2.	Airspeed	<i>Reduce to minimum for safe flight</i>

3.14.1.2 Red Warning Message “WATER TEMP”

Cause:

Coolant temperature exceeds approved maximum

Procedure:

1.	Throttle	<i>reduce power to minimum for flight and increase speed as practical</i>
2.	Land	<i>AS SOON AS POSSIBLE</i>

Caution

Be prepared for engine failure and EMERGENCY LANDING

3.14.1.3 Red Warning Message “OIL TEMP”

Cause:

Oil temperature exceeds approved maximum temperature

Procedure:

1.	Throttle	<i>reduce power to minimum for flight and increase speed as practical</i>
2.	Monitor	<i>Monitor oil pressure</i>
3.	Land	<i>AS SOON AS POSSIBLE</i>

3.14.1.4 Red Warning Message “OIL PRESS”

3.14.1.4.1 Oil pressure below 0.8 bar – 12 PSI

Cause:

Oil pressure below approved minimum pressure

Procedure:

1.	Throttle	<i>Reduce power to minimum for flight</i>
2.	Land	<i>AS SOON AS POSSIBLE</i>

Caution

Be prepared for engine failure and EMERGENCY LANDING

3.14.1.4.2 Oil pressure above 7 bar – 101 PSI

Cause:

Oil pressure above approved maximum pressure. This may happen during start at very low ambient temperatures.

Procedure:

Reduce engine speed and check the oil pressure again once it has reached a higher oil temperature

3.14.1.5 Red Warning Message « FUEL PRESS »

Cause:

Abnormal fuel pressure.

Procedures:

3.14.1.5.1 Fuel press <2.5 bar – 36 PSI

If engine delivers power

1.	Fuel pressure	<i>Monitor</i>
2.	Check fuel shut-off valve	<i>OPEN</i>
3.	Altitude	<i>Descent as practical</i>
If the pressure goes back to normal values		
4.	Land	<i>At nearest suitable airfield</i>

Caution

Probable single fuel pump failure, land at the nearest suitable airfield.

Be prepared for engine failure and EMERGENCY LANDING

If fuel pressure remains <2.5 bars (36 PSI) at altitude < 7000ft		
5.	LAND	<i>AS SOON AS POSSIBLE</i>

WARNING

Abnormally low fuel pressure

Be prepared for engine failure and EMERGENCY LANDING

3.14.1.5.2 Fuel press <1.5 bar – 22 PSI (+ fuel odours) °

Probable major fuel leak in pressurized injection system. Risk of Fire : kill the engine.

1.	Fuel shut-off valve	<i>CLOSE</i>
2.	Engine Key Switch StartAssist	<i>OFF</i>
3.	EMGY switch	<i>OFF</i>
4.	EMERGENCY LANDING	<i>PREPARE</i>

3.14.1.5.3 Fuel pressure > 3.8 bar – 55 PSI

Fine fuel filter probably severely clogged, and bypass inoperative.

- On ground : cancel flight, maintenance required.
- In flight : no immediate action required. Land at the Nearest Suitable Airfield. Monitor engine parameters and behaviour. In case of doubt, land ASAP.

Caution

Be prepared for engine failure and EMERGENCY LANDING

Maintenance required before next flight.

3.14.1.6 Red Warning Message “VOLTS 1”

Cause:

Abnormal voltage on essential bus (VOLTS1)

Procedure:

3.14.1.6.1 Essential bus voltage VOLTS1 <12.5 V

Essential electrical bus voltage is below 12.5 V - Alternator A or B probably inoperative or the Charge / Over-Voltage circuit breaker “Charge/OV” was disengaged.

The battery is no longer charged, and charge status is critical.

1.	Charge/OV circuit breaker	<i>Check ENGAGED</i>
2.	GENERATOR FAULT procedure	<i>Apply</i>

Caution

Be prepared for total loss of electrical systems including flaps and trims

Note

If engine ECU bus B “Volts B” voltage is normal, engine normal operation

3.14.1.6.2 Essential bus voltage VOLTS1> 15.2V

Battery charging voltage regulator probably faulty. Severe overvoltage. Damage may occur to electrical device.

1.	Charge/OV circuit breaker	<i>PULL to disengage</i>
2.	GENERATOR FAULT procedure	<i>Apply</i>

Caution

Battery no longer charged.

A 80% loaded battery allows 1h10 min of flight with the standard electrical loads in cruise

3.14.1.7 Red Warning Message “VOLTS B”

Cause:

Abnormal voltage on engine ECU (VOLTS B)

Procedure:

3.14.1.7.1 Engine ECU voltage Volts B < 9V

Engine ECU supply voltage critically low – Alternator A+B probably inoperative.

1.	EMGY switch	<i>Switch ON</i>
2.	GENERATOR FAULT procedure	<i>Apply</i>

3.14.1.7.2 Engine ECU voltage Volts B >15V

Engine ECU supply voltage too high. Probable fault in Rotax internal power generation regulation. Damage may occur to engine electrical systems.

1.	Throttle	<i>reduce RPM to minimum for flight</i>
2.	Land	<i>AS SOON AS POSSIBLE</i>

Caution

Be prepared for engine failure and EMERGENCY LANDING

3.14.1.8 Red Warning Message “ENGINE ECU”

This warning is redundant with a steady LANE A or LANE B warning light. Report to § 3.14.5 below

3.14.1.9 Red Warning Message “AMPS”

3.14.1.9.1 Current < -3 Amps

Cause ;

The battery discharges into the aircraft systems.

- This is normal when the engine is stopped.
- This is not normal if the engine is running (except in emergency power mode): faulty charging system, or current draw above generator capacity which is usually impossible (would mean a large short-circuit).

1.	Charge/OV circuit breaker	<i>Check ENGAGED</i>
2.	Faulty equipment	<i>Switch OFF</i>
3.	“VOLTS 1” and “VOLTS B”	<i>Monitor</i>
4.	GENERATOR FAULT procedure	<i>Apply</i>
5.	Land	<i>At the Nearest Suitable Airfield</i>

Caution

Be prepared for total loss of electrical systems including flaps and trims

3.14.1.9.2 Current > 30 Amps

Cause:

Battery current recharge above generator capacity, which is normally impossible.

1.	voltage “Volts1” and “Volts B”	<i>Monitor</i>
2.	BATT DEFAULT warning light status	<i>Monitor</i>
3.	Charge/OV circuit breaker	<i>Disengage</i>
4.	GENERATOR FAULT procedure	<i>Apply</i>

Caution

Be prepared for total loss of electrical systems including flaps and trims

3.14.1.10 Red Warning Message “EGT”

Cause :

One or several Exhaust Gas Temperatures are above approved limits.

This can be the consequence of a faulty sensor, or an engine problem.

Procedure

- Check engine behaviour :
 - o Unusual noise / vibration ?
 - o Unusual odours (smoke) ?
- **A high EGT with the unusual behaviour above can be the sign of an engine malfunction including a broken exhaust manifold . RISK OF FIRE !**

1.	Throttle	<i>reduce power to minimum for flight</i>
2.	Engine behaviour/parameters	<i>Keep monitoring</i>
3.	Land	<i>AS SOON AS POSSIBLE</i>
If smoke confirmed		
4.	Engine Key Switch StartAssist	<i>OFF</i>
5.	Fuel shut off valve	<i>OFF</i>
6.	Search a suitable landing site and prepare for an EMERGENCY LANDING	

- **If the engine runs smooth/as usual**
 - o Display the detailed engine monitoring page on the G3X
 - o Check how many EGT are abnormally high.

If only one EGT abnormally high (or erratic), the 3 other ones are normal, and the engine runs smooth, it is probably a faulty sensor. Keep monitoring your engine behaviour and parameters. Flight is possible to your destination at your own discretion. A maintenance inspection is required.

If more than one EGT abnormal (even if the engine seems running “normally”): probable engine malfunction. Risk of damage to the engine.

1.	throttle	<i>reduce power to minimum for flight</i>
2.	Engine behaviour/parameters	<i>Keep monitoring</i>
3.	Land	<i>AS SOON AS POSSIBLE</i>

3.14.2 MASTER CAUTION (amber caution light)

Cause:

A CAUTION message is displayed on MFD.

CAUTION (amber): Requires pilot awareness and possible future corrective action.

Procedure:

Check MFD for caution message (displayed in amber letters on a black background).

Apply corresponding procedure.

CAUTION list:

- OIL TEMP
- WATER TEMP
- OIL PRESS
- FUEL PRESS
- VOLTS 1
- VOLTS B
- ENGINE ECU
- AMPS
- FUEL QTY
- EGT
- AIRFRAME TEM

3.14.2.1 Amber Caution Message “WATER TEMP”

3.14.2.1.1 Coolant temperature below 50°C – 122°F

Cause :

Coolant temperature below normal operation recommendations

Procedure:

- On ground : Let temperatures warm up above 50°C before holding point checks and take-off
- In flight: If possible, increase power to raise the temperatures. If possible, do not apply full power suddenly.

3.14.2.1.2 Coolant temperature above 110°C – 230°F

Cause :

Coolant temperature high

Procedure:

1.	Throttle	<i>reduce power to minimum for flight and increase speed as practical</i>
----	----------	---

3.14.2.2 Amber Caution Message “OIL TEMP”

3.14.2.2.1 Oil temperature below 50°C – 112°F

Cause :

Oil temperature below normal operation recommendations

Procedure:

- On ground : Let temperatures warm up above 50°C before holding point checks and take-off
- In flight: If possible, increase power to raise the temperatures. If possible, do not apply full power suddenly.

3.14.2.2.2 Oil temperature above 110°C – 230°F

Cause :

Oil temperature high

Procedure:

1.	Throttle	<i>reduce power to minimum for flight and increase speed as practical</i>
----	----------	---

3.14.2.3 Amber Caution message “OIL PRESS”

3.14.2.3.1 Oil pressure below 2 bars – 29 PSI

Cause : oil pressure below normal operation values. This may happen when oil is hot and engine idling.

This is not normal if RPM > 2000

Procedure:

1.	Throttle	<i>Reduce power to minimum for flight</i>
----	----------	---

3.14.2.3.2 Oil pressure above 5 bars – 72 PSI

Cause:

Oil pressure above approved maximum pressure. This may happen during cold start at low ambient temperatures.

Procedure:

Reduce engine speed and check the oil pressure again once it has reached a higher oil temperature

3.14.2.4 Amber Caution Message “FUEL PRESS”

3.14.2.4.1 Fuel pressure between 3.2 to 3.8 bar (46-55 PSI)

Cause:

Fine fuel filter probably partially clogged.

Procedure:

Flight is possible to your destination at your own discretion

Note

Maintenance should be carried out

3.14.2.4.2 Fuel pressure between 2.5 to 2.8 bar (46-55 PSI)

Cause:

Possible partial obstruction of fuel delivery.

Procedure:

1.	Fuel pressure	Monitor
2.	Check fuel shut-off valve	OPEN
3.	Altitude	Descent as practical

Flight is possible to your destination at your own discretion

Note

Maintenance should be carried out

3.14.2.5 Amber Caution Message “VOLTS 1”

Cause:

Abnormal essential bus voltage > 14.6 V . Battery charging voltage regulator probably faulty. Moderate overvoltage.

Procedure:

1.	Charge/overvoltage circuit breaker	<i>PULL to disengage, then re-engage ONCE</i>
If no effect		
2.	Charge/overvoltage circuit breaker	<i>PULL to disengage</i>
3.	GENERATOR FAULT procedure	<i>Apply</i>

3.14.2.6 Amber Caution Message “VOLTS B”

Cause:

Engine ECU supply voltage below normal level

Procedure:

1.	Engine ECU bus B voltage “Volt B”	<i>monitor</i>
2.	Essential bus voltage “Volts 1”	<i>monitor</i>
3.	Land	<i>At nearest suitable airfield</i>

Caution

If engine ECU voltage decreasing towards 9V, be prepared to switch EMGY on and apply GENERATOR FAULT procedure

3.14.2.7 Amber Caution Message “ENGINE ECU”

This warning is redundant with a flashing LANE A or LANE B warning light

Report to §3.14.3 or §3.14.4

3.14.2.8 Amber Caution Message “AMPS”

3.14.2.8.1 Current $-3 < I < 0$ Amps

Cause : moderate discharge of the battery in the aircraft electrical systems. This may be possible for a short while, with no consequence. If the problem remains :

1.	Charge/OV circuit breaker	<i>Check ENGAGED</i>
2.	Faulty equipment	<i>Switch OFF</i>
3.	voltage “Volts 1” and “Volts B”	<i>Monitor</i>

3.14.2.8.2 Current > 28 Amps

Cause: Battery current recharge above generator capacity, which is normally impossible.

1.	voltage “Volts1” and “Volts B”	<i>Monitor</i>
2.	BATT DEFAULT warning light status	<i>Monitor</i>
3.	Charge/OV circuit breaker	<i>Disengage</i>
4.	GENERATOR FAULT procedure	<i>Apply</i>

Caution

Be prepared for total loss of electrical systems including flaps and trims

3.14.2.9 Amber caution Message “FUEL LVL”

This message is redundant with the amber caution light “FUEL LEVEL”. See §3.14.7 below.

3.14.2.10 Amber Caution Message “EGT”

Cause:

One or several Exhaust Gas Temperatures are above normal operating values. This can be the consequence of a faulty sensor, or an engine problem.

Procedure

- Check engine behaviour :
 - o Unusual noise / vibration ?
 - o Unusual odours (smoke) ?
- **A high EGT with the unusual behaviour above can be the sign of an engine malfunction including a broken exhaust manifold . RISK OF FIRE !**

1.	throttle	<i>reduce power to minimum for flight</i>
2.	Engine behaviour/parameters	<i>Keep monitoring</i>
3.	Land	<i>AS SOON AS POSSIBLE</i>
If <u>smoke</u> confirmed		
4.	Engine Key Switch StartAssist	<i>OFF</i>
5.	Fuel shut off valve	<i>OFF</i>
6.	Search a suitable landing site and prepare for an EMERGENCY LANDING	

- **If the engine runs smooth/as usual**
 - o Display the detailed engine monitoring page on the G3X
 - o Check how many EGT are significantly above the other ones

If only one EGT abnormally high (or erratic), the 3 other ones are normal, and the engine runs smooth, it is probably a faulty sensor. Keep monitoring your engine behaviour and parameters. Flight is possible to your destination at your own discretion. A maintenance inspection is required.

If more than one EGT abnormal (even if the engine runs “normally”): possible engine malfunction. Risk of damage to the engine.

1.	Throttle	<i>reduce power to minimum for flight</i>
2.	Engine behaviour/parameters	<i>Keep monitoring</i>
3.	Land	<i>AS SOON AS POSSIBLE</i>

3.14.2.11 Amber Caution Message “AIRFRAME TEM”

Cause : aeroplane exposed to the sun for too long without protection. The airframe temperature is above approved limit of 54°C.

Procedure : on ground start engine and perform engine warm up procedures and taxi on ground to cool down the structure with airflow. Check temperature again. Do not take off with the airframe above 54°C.

In Flight : Land at the Nearest Suitable Airfield.

3.14.3 ONE LANE (A or B) FLASHING (amber caution light)

Cause:

One flashing light LANE A or LANE B indicates a minor default in the engine ECU Lane A or B. Full engine performance and nominal engine modes remain available.

Procedure:

- On ground: one-way flight to maintenance facilities allowed.
- In flight: no immediate action required.

3.14.4 BOTH LANES (A and B) FLASHING (amber caution light x2)

Cause:

Both flashing lights indicate a minor default in each engine ECU Lane A and B. Full engine performance and nominal engine modes remain available, no immediate hazard. But as both Lanes are concerned, in the case of any additional failure the engine may become inoperative (no backup).

Procedure:

- On ground: cancel flight.
- In flight: Land At Nearest Suitable Airfield.

3.14.5 ONE LANE (A or B) STEADY ON (amber caution light)

Cause:

One steady light LANE A or LANE B indicates a Major Default in the engine ECU Lane A or B. The other Lane will take control of the engine management. Full engine performance is available, but possibly in a degraded mode with increased fuel consumption. In the case of any additional failure the engine may become inoperative (no backup).

Procedure:

- On ground: cancel flight
- In flight: Land At Nearest Suitable Airfield

Caution

Engine running full rich. Fuel consumption increased. Check fuel flow and re-evaluate fuel range.

Note

Full engine performance is available

3.14.6 BOTH LANES (A and B) STEADY ON (amber caution lights x2)

Cause:

If both LANE A and LANE B are steady ON, it indicates a Major Default in the engine ECU on the Lane A and the Lane B. The engine management is uncertain, the system relies on default values and tries to maintain operation. The engine may become inoperative any time (from loss of engine power control to complete in-flight shut down).

Procedure:

- On ground: cancel flight
- In flight:
 - Do not try to recycle any Lane (keep on position “BOTH”)
 - Keep parameters steady as far as practicable
 - Land AS SOON AS POSSIBLE

Caution

Loss of engine power / in flight shut down possible. Be prepared for an EMERGENCY LANDING

3.14.7 FUEL LEVEL (amber caution light)

Cause: Usable fuel less than 5 litres – 1.3 USgal (at cruise pitch attitude).

Note : this warning light is redundant with the master caution light + “FUEL LVL” above (see §3.14.2.9.)

Procedure: Land AS SOON AS POSSIBLE. Avoid prolonged slips and high pitch angles as practical.

Note

approx. 20 minutes endurance available

3.14.8 FLAP DEFAULT (amber caution light)

Cause: overload detected in the flap control system.

Procedure:

Flaps may be inoperative or blocked in intermediate position.

Monitor speed if flaps extended.

Monitor Flaps position (on the MFD and real position on the wing)

Reduced flaps landing: increase approach speed:

Flaps UP: IAS = 140 km/h – 76 kts

Flaps T/O: IAS = 125 km/h – 68 kts

Landing distance increased by 100 meters.

3.14.9 BATTERY DEFAULT (amber caution light)

Cause: fault detected by the internal Battery Management System

Procedure:

The table below shows the most common fault conditions in flight and associated procedures:

Status	Volts 1	Possible Cause	Procedure
Continuous Flashing	< 13.2V	Battery over-discharged	Check Charge/OV circuit breaker ENGAGED
Continuous Flashing	13.2V-14.6V	Weak or failing cell	No immediate action required.
Continuous Flashing	> 15.2V	Over-charging	PULL OUT charge/OV circuit breaker
Flashing (random)	13.2V to 14.6V	Cell to cell charge levels are not balanced	No immediate action required.
Steady	Any voltage	BMS electronic issue	No immediate action required.

3.14.10 EMGCY PWR (amber caution light)

Cause: EMERGENCY POWER MODE is active (the EMGY switch is ON).

Procedure:

- if not switched on intentionally, switch OFF.
- if switched on purpose: apply GENERATOR FAULT procedure.

3.14.11 START PWR (blue status light)

Cause: engine electric systems supplied by the battery.

Procedure:

On ground / Before start with LANES ON: normal status.

On ground / after start and RPM >1500: shut down the engine.

In flight: abnormal status, without immediate consequence. No immediate action required.

3.15 Charge/OV circuit breaker popped-out

Cause:

Overcharge or overvoltage detected.

Procedure:

1.	Charge/OV circuit breaker	Re-engage one time
2.	Essential bus voltage "Volts 1"	Monitor
If voltage > 14.6 V		
3.	Charge/OV circuit breaker	PULL to disengage
4.	GENERATOR FAULT procedure	apply

WARNING

If the breaker disengages again, NEVER try to re-engage it and NEVER hold it engaged.
Risk of electric device damage and fire !

Note

the engine will keep running normally.

3.16 GENERATOR FAULT procedures

3.16.1 EMGY switched OFF

The battery is no longer charged. It supplies energy to on board electric systems. Engine electric systems do not rely on the battery : engine should run normally.

1.	Non-essential equipment	<i>Switch OFF</i>
2.	Essential bus voltage "Volt1"	<i>Monitor</i>
3.	Land	<i>At the Nearest Suitable Airfield</i>

Note

A 80% loaded battery allows 1h10 min of flight with the standard electrical loads in cruise

If Volts 1 decreases rapidly and/or falls below 12.5 V:

4.	Land	<i>AS SOON AS POSSIBLE</i>
----	------	----------------------------

Caution

be prepared for total loss of electrical systems including flaps and trims

3.16.2 EMGY switched ON

This case should only occur in case of dual generator failure. The battery is not charged anymore and supplies electric power to both on board equipment AND engine systems. Only essential equipment remains powered. Following equipment are no longer powered:

Transponder	AOA indicator	Fuel level quantity	Flaps
USB	Landing lights	Flash lights	Pedal adjustment
Nav Lights	Map light		

1.	Non-essential equipment	<i>Switch OFF</i>
2.	Essential bus voltage "Volt1"	<i>Monitor</i>
3.	Engine ECU bus voltage "Volts B"	<i>Monitor</i>
4.	Land	<i>AS SOON AS POSSIBLE</i>

Caution

The battery is not charged anymore. The battery endurance for essential equipment and engine electric systems is less than 58/ minutes. Land ASAP !

If Volts 1 and/or Volts B decrease rapidly and/or fall below 12.5 V

5.	Land	<i>AS SOON AS POSSIBLE</i>
----	------	----------------------------

WARNING

The battery is not charged anymore, and charge status is critical.

Be prepared for an engine failure and total loss of electrical systems including flaps and trims.

Be prepared for a power-off EMERGENCY LANDING with no trims, no flaps.

3.17 Ballistic rescue system activation

Once the parachute is determined to be the only alternative available for saving the aircraft occupants, deploy the system without delay.

1.	Domain for activation	<i>confirmed</i>
2.	Engine Key Switch <input type="button" value="StartAssist"/>	<i>OFF</i>
3.	BRS handle safety pin	<i>Check REMOVED</i>
4.	(time permitting) : Seat belts	<i>Fasten, tighten</i>
5.	BRS Handle	<i>PULL</i>
6.	FUEL shut off valve	<i>OFF</i>
7.	MASTER Switch	<i>OFF</i>
8.	Seat belts	<i>Fasten, tighten</i>
9.	Position before impact	<i>Emergency position (see §7.14)</i> 

Note

See §7.14 for detailed information on BRS

3.18 Abnormal procedure: Transponder management in case of G3X failure

Note

The transponder GTX335R is a "remote" unit without instrument panel interface. It is controlled only by the G3X touch screen.

In case of failure of the G3X display, the transponder will remain active on the last mode and squawk code as long as it remains powered. You remain identified on the ATC radars. The VHF remains controllable through its display unit: you can still communicate with the air traffic control and explain you can't change squawk if requested.

3.19 G3X failures and annunciation

3.19.1 ADC FAIL

Air Data Computer failure is indicated by:

- Amber ADC FAIL annunciation
- Red X over the airspeed and altitude tapes.
- Red X over the vertical speed tape.
- Red X over the TAS and OAT fields.

Procedure:

1.	Use primary airspeed indicator and altimeter
----	--

3.19.2 MESSAGE

Amber MESSAGE annunciation indicates new system message.

Press the flashing message annunciation to view a new system message

3.19.3 ATTITUDE FAIL

Attitude failure is indicated by:

- Amber AHRS FAIL annunciation
- removal of the sky/ground presentation.
- Red X over the sky/ground presentation.
- Amber ATTITUDE FAIL on the PFD display

Procedure:

1.	Use primary attitude indicator
----	--------------------------------

3.19.4 AHRS ALIGN

During flight, Amber AHRS ALIGN annunciation indicates that the AHRS is beginning to fail and the internal sensors are trying to realign themselves. The attitude presentation behind the annunciation is still valid but should be crosschecked using primary flight instruments.

During system initialization, the AHRS displays the message 'AHRS ALIGN, KEEP WINGS LEVEL' over the attitude indicator. The AHRS should display valid attitude and heading fields typically within the first minute of power-up.

The AHRS can align itself both while taxiing and during level flight

3.19.5 ALIGNING KEEP WINGS LEVEL

If the "ALIGNING KEEP WINGS LEVEL" indication occurs during flight, the G3X Touch has detected an invalid attitude solution and will not display any attitude information.

Procedure:

1.	Attitude information	<i>Use primary attitude indicator</i>
2.	Aircraft attitude	<i>Maintain 1° pitch up and wings level as practical Avoid more than 10° bank and +/-5° pitch</i>

The system should display attitude when internal accuracy tolerances are met
If attitude information does not recover:

3.	Attitude information	<i>Use primary attitude indicator</i>
----	----------------------	---------------------------------------

3.19.6 EIS failure

EIS failure is indicated by the loss of displayed information on the EIS, including a blank, frozen, red 'X' over the display, or unresponsive display of EIS parameters.

Procedure:

1.	Engine throttle	<i>Position to ensure operation within engine limitation</i>
2.	Land	<i>At the Nearest Suitable Airfield</i>

3.19.7 G3X Touch Failure Annunciations

If a G3X Touch function fails, a large red 'X' is typically displayed over the instrument(s) or data experiencing the failure. Upon G3X Touch power-up, certain instruments remain invalid as equipment begins to initialize. All instruments should be operational within one minute of power-up.

If any instrument remains flagged the G3X Touch should be serviced by an Elixir-Aircraft and/or Garmin-authorized repair facility.

WARNING

Changing the G3X setup made by the manufacturer is prohibited to pilot's / owners and unauthorised maintenance personnel. If you think you have inadvertently entered in the configuration pages seek advice from Elixir Aircraft.

3.19.8 Heading failure, loss of magnetometer data, magnetic field error

A heading failure, loss of magnetometer data, or magnetic field error is indicated by removal of the digital heading readout, a red X, and an amber "HDG" annunciation on the display.

Procedure:

1.	Flight instruments	Use primary magnetic compass
----	--------------------	------------------------------

Note

If the G3X Touch HSI has a valid GPS signal the G3X Touch HSI instrument will display the GPS track information in magenta.

3.19.9 PFD failure

PFD failure is indicated by the loss of displayed information on the PFD, including a blank, frozen, or unresponsive display.

Procedure:

2.	Flight instruments	Use primary flight instruments
----	--------------------	--------------------------------

3.19.10 Navigation data failure

Navigation data failure may be indicated by any or all of the following:

- Loss of course deviation information on PFD
- Loss of bearing pointer on HSI

Procedure:

1.	Navigation information	Ignore
2.	Navigate	Under Visual Flight Rules

Note

The Garmin G3X Touch GPS is not a class A navigation aid, it is provided for information purposes only. Only use in VMC with ground or sea in sight.

3.20 External and cockpit lighting failures (at night)

3.20.1 LDG light failure

Flight is possible to your destination at your own discretion.

Before landing:

1.	FLASH Light	Check ON
2.	NAV lights	Check ON
3.	Air traffic control	Advise as practical

Note

FLASH and NAV lights help to see the runway during flare

3.20.2 NAV and/or FLASH light failure

Flight is possible to your destination at your own discretion.

1.	Land lights	ON
2.	Air traffic control	Advise as practical

3.20.3 Instrument backlight failure

1.	Map light	Use as practical
2.	Personal headlamp	Use as practical

3.20.4 Map light failure

1.	Personal headlamp	Use as practical
----	-------------------	------------------

3.20.5 Terrain and obstacle annunciations

If terrain and obstacle databases are installed, the following alerts and procedures apply:

Caution

Terrain and obstacle information should only be used as an aid to situational awareness.

3.20.5.1 Terrain warning

Aural alert	Visual alert
Terrain Ahead! Pull Up!	<div style="text-align: center;"> TERRAIN OR OBSTACLE OR TERRAIN → </div>
Terrain, Terrain Pull up! Pull Up!	
Obstacle Ahead! Pull Up!"	
Obstacle, Obstacle Pull Up! Pull Up!	
Sink Rate, Pull Up!	
Pull Up!	

Note

The arrow indicates the terrain or obstacle is outside of the synthetic vision field of view.

Procedure:

- If operating under VMC, ensure terrain and obstacle avoidance according to visual flight rules.
- Else:

1.	Initiate climb	Target speed 140km/h – 76 kts
2.	Throttle	Max take-off power
3.	Flaps	Take-off
4.	Speed	115km/h – 62 kts
5.	Terrain avoidance	Determine avoidance action based on all available information

WARNING

Aircraft is approved for operation under VMC only.

3.20.5.2 Terrain caution

Aural alert	Visual alert
CAUTION, Terrain	
CAUTION, Terrain Ahead	TERRAIN
CAUTION, Obstacle	OR
CAUTION, Obstacle Ahead	OBSTACLE
CAUTION, Sink Rate	OR
	← TERRAIN

Note

The arrow indicates the terrain or obstacle is outside of the synthetic vision field of view

Procedure:

Take corrective action until the alert ceases. Using all available information to determine the appropriate action, alter the flight path away from the threat by stopping descent, climbing, and/or turning

Intentionally left blank

4 Normal procedures

4.1	Introduction	4-2
4.2	Pre-flight inspection.....	4-2
4.3	Engine starting.....	4-6
4.3.1	Before engine start	4-6
4.3.2	Engine start	4-6
4.3.3	Engine warm-up	4-8
4.4	Taxiing	4-8
4.5	Holding point checks	4-8
4.6	Take-off	4-11
4.7	Climb	4-12
4.7.1	Best angle of climb speed V_x	4-12
4.7.2	Best rate of climb speed V_y	4-12
4.7.3	Recommended flight speed	4-12
4.8	Cruise	4-12
4.9	Descent	4-12
4.10	Approach	4-12
4.11	Landing	4-13
4.11.1	Before landing:	4-13
4.11.2	Landing	4-13
4.11.3	After landing	4-13
4.11.4	Engine shut down	4-13
4.12	Balked landing procedure.....	4-13
4.13	Aircraft parking.....	4-14

4.1 Introduction

This section provides checklists and recommended procedures for normal operation of the aircraft.

4.2 Pre-flight inspection

Carry out the pre-flight inspection every day prior to the first flight or if the plane was left unattended. Incomplete or careless inspection can cause an accident. Carry out the inspection following the instructions in the Inspection Check list.

Note

The word "condition", used in procedures or pre-flight check, means visual/manual check of surface, damage; deformation, scratches, attrition, corrosion, icing or other damages, which may lead to flight safety degradation.

Carry out the pre-flight inspection as follows:

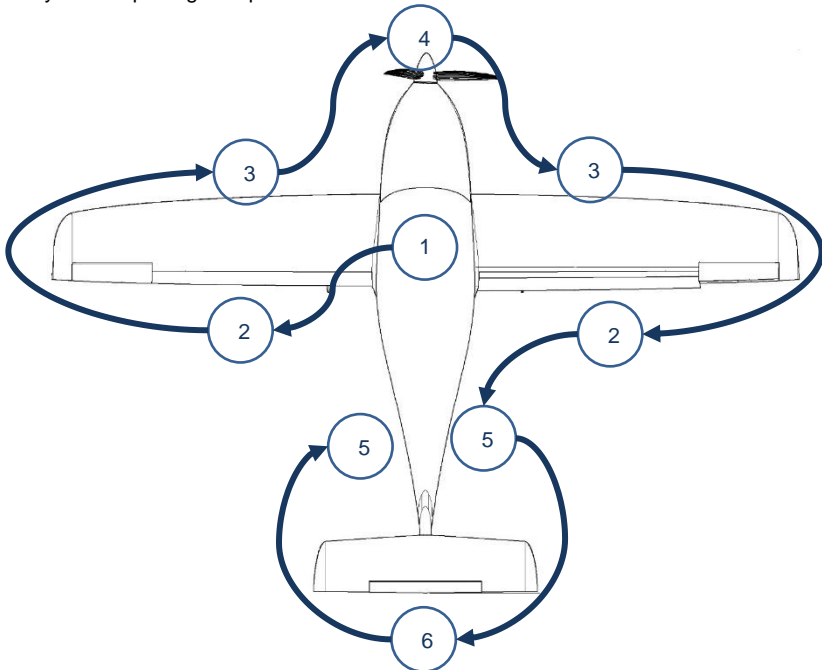

Cabin			
1	<ul style="list-style-type: none"> • Canopy • Check cockpit for lose objects • Engine Key Switch StartAssist • BRS safety pin • MASTER Switch • MFD • NAV, FLASH, LDG Lights • Instrument light dimmer • Map light dimmer • Day/Night switch • Flight controls • All switches • MASTER Switch • Mandatory documents 	<p>Condition of attachment and locking mechanism, cleanness, Gas springs condition</p> <ul style="list-style-type: none"> - OFF, key removed -check SECURED - ON - ON, check battery voltage, recharge if U<12.8 V - check Fuel quantity indication - ON, check functioning - ON, check functioning for Night VFR flight - ON, check functioning for Night VFR flight - Check warning light brightness change - visual inspection, function, clearance, free movement up to stops, play, check wing flaps and trims operation - OFF - OFF - On board 	
	Wing trailing edge		
	2	<ul style="list-style-type: none"> • Wing flap • Main landing gear • Fence • Aileron • Wing tip 	<ul style="list-style-type: none"> - surface condition, attachment, clearance - Wheel, fairing, leg and brake attachment, condition, pressure of tire - condition, bonding to wing skin - surface condition, attachment, clearance, free movement, trim tab surface condition (right aileron only), attachment - Surface condition, attachment, FLASH/NAV condition, attachment.

3	Wing leading edge	
	<ul style="list-style-type: none"> Wing upper surface 	- Condition, cleanliness. WARNING: The Elixir wing skin is structural. In case of any damage to the wing surface (scratch, indentation, impact damage), cancel flight and seek advice from the manufacturer.
	<ul style="list-style-type: none"> Leading edge 	- surface condition, cleanliness - leading edge stall strips present - LAND light plexiglass shield condition (cracks, clean, transparency)
	<ul style="list-style-type: none"> Pitot probe (right wing) 	- Remove cover - condition, attachment, cleanliness
4	Around the engine cowling	
	<ul style="list-style-type: none"> Nose gear 	- Wheel, fairing and leg attachment, condition, pressure of tire
	<ul style="list-style-type: none"> Engine cowling 	- Condition
	<ul style="list-style-type: none"> Propeller and spinner 	- Condition
	<ul style="list-style-type: none"> Engine mount and exhaust pipe 	- Condition, attachment
	<ul style="list-style-type: none"> Oil quantity 	- Check
	<p><i>-Before this check, ensure Engine Key Switch, EMGY and MASTER Switch are OFF --Open the oil tank and then turn the propeller by hand in direction of engine rotation several times to pump oil from the engine into the oil tank – this process is finished when air is returning back to the oil tank and can be noticed by a murmur from the open oil tank – see the Rotax Operator’s manual)</i></p>	
		- Check oil level and replenish as required
		- Close the oil tank
	<ul style="list-style-type: none"> Coolant quantity 	- Check level in the overflow bottle
<p><i>If level under minimum, remove upper engine cowling, check level in expansion tank. Level in the expansion tank should be full flush. Replenish expansion tank and overflow bottle as required, max 0.2 L. If more than 0.2 L required, abort flight and make an engine inspection for leaks / overheat.</i></p>		
<ul style="list-style-type: none"> Fuel system 	- draining (both gascolator and belly drains) - check for water and foreign matters.	

5	Fuselage	
	• Fuselage surface	- Condition, cleanliness
	• Antennas	- Attachment
	• Static ports	- unobstructed
6	Tail	
	• Vertical fin	- Condition of surface - Attachment - Free movement - Rudder stops
	• Tailplane	- Condition of surface - Attachment (apply only light forces at tips) - Free movement / play (max +/-5 mm fore-aft and up-down at tailplane tip) - Trim tab surface condition, attachment / play (max +/-1.5 mm at tab trailing edge; apply only light forces on control surface) - fence (x1) and vortex generators (x2) present on both sides, condition, bonding to elevator skin

Note

Visually check fuel quantity in the tank -consistency with fuel gage

4.3 Engine starting

4.3.1 Before engine start

- | | | | |
|----|------------------------|-----------|---|
| 1. | Glareshield extensions | removable | <i>Install for Night VFR flight</i> |
| 2. | Day/Night Switch | | <i>OFF for Day VFR flight
ON for Night VFR flight</i> |
| 3. | Cockpit lights | | <i>Set dimmer depending on light conditions</i> |
| 4. | Flight controls..... | | <i>Free & correct movement</i> |
| 5. | Canopy..... | | <i>Close and lock</i> |
| 6. | Seat belts..... | | <i>Fasten</i> |
| 7. | Parking brake..... | | <i>Set</i> |
| 8. | Circuit breakers | | <i>Check all Engaged</i> |
| 9. | GVNR propeller switch | governor | <i>Check ON</i> |

4.3.2 Engine start

- | | | | |
|-----|--------------------------------------|--------------------|--|
| 1. | Fuel shut off valve..... | | <i>ON</i> |
| 2. | MASTER Switch | | <i>ON</i> |
| 3. | Garmin MFD | | <i>Active</i> |
| 4. | Gamin MFD | | <i>Select PFD + EIS Mode</i> |
| 5. | FLASH lights | | <i>ON</i> |
| 6. | LANE Selector | | <i>Switch to BOTH</i> |
| 7. | Engine Key Switch | StartAssist | <i>Switch to LANES</i> |
| 8. | “LANE A” and “LANE B” warning lights | | <i>Check ON then OFF after around 3 seconds</i> |
| 9. | Engine Key Switch | StartAssist | <i>RUN</i> |
| 10. | Fuel pressure | | <i>Check at 3 bar – 43 PSI</i> |
| 11. | Throttle position | | <i>Set according to table below</i> |
| 12. | Propeller area..... | | <i>Clear</i> |
| 13. | Engine Key Switch | StartAssist | <i>Select START until the engine runs and release.
(Max 10s and let starter cool down 2 minutes before next attempt)</i> |
| 14. | Throttle..... | | <i>Set 2000 RPM</i> |
| 15. | Oil pressure | | <i>Check (above 3 bars – 43 PSI within 10 seconds).</i> |
| 16. | Engine indications..... | | <i>Check</i> |
| 17. | warning lights | | <i>Check LANE A, LANE B and START PWR OFF.</i> |

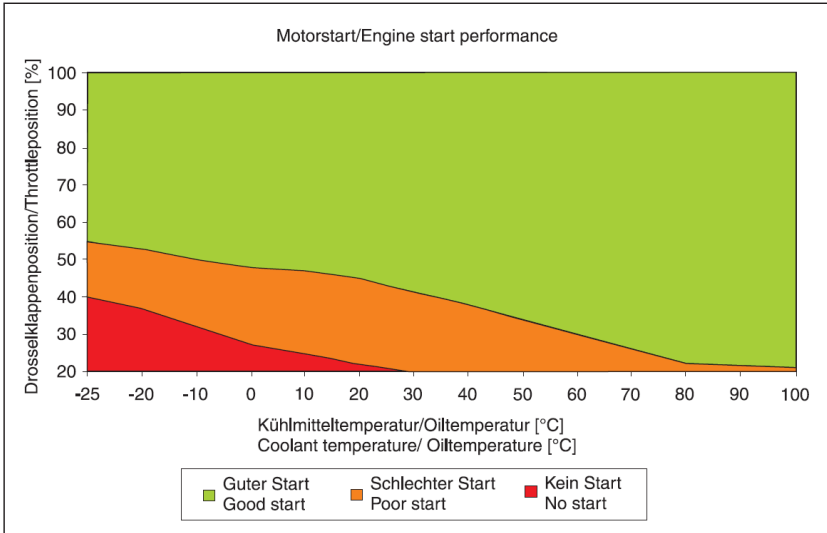

Before starting, adjust the throttle position (indicated on the G3X between MAN and RPM) according to the table above. The boundary between the orange and green zones offers an optimal compromise between a good start and avoiding excessive rpm during start-up.

4.3.3 Engine warm-up

- | | |
|-----------------------|---|
| 1. Throttle..... | <i>Warm up engine at approx. 2000 RPM for approx. 2 minutes</i> |
| 2. | <i>Continue at 2500 RPM until oil temperatures reaches 50°C – 122°F</i> |
| 3. Engine indications | <i>Check</i> |

4.4 Taxiing

- | | |
|-----------------------|--------------------------------|
| 1. NAV lights | <i>ON</i> |
| 2. LDG lights | <i>ON for Night VFR flight</i> |
| 3. Flaps..... | <i>UP (0°)</i> |
| 4. Parking brake..... | <i>Release</i> |
| 5. Brakes..... | <i>Check</i> |

Apply power and brakes as needed.

Use rudder pedals to steer.

Use also differential braking to make short turns at very low speed.

Do not use wheel brakes more than necessary to avoid :

- excessive wear,
- disc over-heating and potential loss of braking efficiency
- potential risks of fire if dry grass trapped in the fairings touch the hot disc.

4.5 Holding point checks

Note

When possible, the engine run-up should be performed with the aircraft heading in the wind and on a clean surface.

1.	Parking brakes	<i>Set</i>
2.	Seat belts	<i>Fastened, tightened</i>
3.	Canopy	<i>Closed and locked</i>
4.	Flight controls	<i>Free movement, observe control surfaces deflection in the right direction</i>
5.	Trims	<i>Set elevator to T/O position and aileron to neutral.</i>
6.	Flight instruments	<i>Check</i>
7.	Altimeter (PFD and analog instrument)	<i>Set</i>
8.	MFD	<i>PFD + EIS mode</i>
9.	Oil pressure	<i>Within limits</i>
10.	Oil temperature	<i>>50°C – 122°F</i>

LANE check

11.	Throttle	<i>Set 3800 RPM</i>
12.	Manifold Pressure	<i>Check between 18 to 20 in.Hg</i>
13.	LANE Selector	<i>Switch to "B"</i>
<p><i>Check</i></p> <ul style="list-style-type: none"> - <i>"LANE A" warning light ON</i> - <i>RPM increase by approx. 100 RPM. A drop in RPMs indicates a problem</i> - <i>"ECO" mode disappears</i> - <i>following engine parameters lost (red X)</i> <ul style="list-style-type: none"> o <i>oil pressure</i> o <i>All EGTs</i> o <i>Water temperature</i> o <i>Fuel flow</i> 		
14.	LANE Selector	<i>Switch to "BOTH"</i>
<p><i>Check</i></p> <ul style="list-style-type: none"> - <i>"LANE A" warning light ON for about 3 seconds and then OFF</i> - <i>RPM back to 3800</i> - <i>Normal Engine indications</i> - <i>"ECO" mode ON</i> 		
15.	LANE Selector	<i>Switch to "A"</i>
<p><i>Check</i></p> <ul style="list-style-type: none"> - <i>"LANE B" warning light ON</i> - <i>RPM increase by approx. 100 RPM. A drop in RPMs indicates a problem</i> - <i>"ECO" mode disappears</i> - <i>following engine parameters lost (red X)</i> <ul style="list-style-type: none"> o <i>oil pressure</i> o <i>oil temperature</i> o <i>Fuel flow</i> o <i>Volts B</i> 		
16.	LANE Selector	<i>Switch to "BOTH"</i>
<p><i>Check</i></p> <ul style="list-style-type: none"> - <i>"LANE B" warning light ON for about 3 seconds and then OFF</i> - <i>RPM back to 3800</i> - <i>Normal Engine indications</i> - <i>"ECO" mode ON</i> 		

Fuel pump check

17.	PUMP TEST switch	<i>press "1". and hold</i>
Observe fuel pressure and engine reaction Fuel pressure must stay within the limits Engine must keep running without any change		
18.	PUMP TEST switch	<i>Release "1"</i>
Observe fuel pressure and engine reaction Fuel pressure must stay within the limits Engine must keep running without any change		
19.	PUMP TEST switch	<i>Repeat steps 17 & 18 with pump "2"</i>

Note

avoid switching rapidly from pump 1 to 2. Both pumps would be inoperative for a short moment and engine would stop.

Idle check

20.	Throttle	<i>IDLE</i>
21.	Idle RPM	<i>Check 1400-1500 RPM</i>

AOA/Stall warning check

22.	"TEST" button on the Garmin GI260 Angle Of Attack indicator	<i>PRESS</i>
<i>Check</i>		
<ul style="list-style-type: none"> - <i>Visual Stall Warning : All chevrons illuminated</i> - <i>Audible Stall Warning : VHF and headsets volume adjusted, clearly audible stall warning "beep"</i> 		

4.6 Take-off

Line-up

1.	Flaps	<i>T/O position</i>
2.	Warning lights	<i>All OFF</i>
3.	BRS handle safety pin	<i>REMOVE</i>

WARNING

Before take-off, manually check the canopy is locked by pushing the canopy upwards.

Take-off

1.	Brakes	<i>RELEASE</i>
2.	Throttle	<i>Full power (max 5 minutes)</i>
3.	Engine parameters	<i>RPM 5200 minimum, increasing with speed Manifold pressure >28 inHg (at sea level) Oil pressure OK</i>
4.	Airspeed indicator	<i>active</i>
5.	Rotation	<i>Rotate smoothly at 100 km/h – 54 kts for lift-off at 110 km/h – 59 kts, accelerate to 115 km/h – 62 kts minimum</i>

Above 300ft AGL – obstacles cleared

6.	Engine parameters	<i>Check</i>
7.	Throttle	<i>Reduce to 5500 RPM</i>
8.	Flaps	<i>UP above 130 km/h (70 kts)</i>
9.	Airspeed	<i>160 km/h – 86 kts</i>
10.	LDG light	<i>OFF</i>

4.7 Climb

4.7.1 Best angle of climb speed V_x

1. Flaps *T/O*
2. Airspeed *115 km/h – 62 kts*

4.7.2 Best rate of climb speed V_y

1. Flaps *UP*
2. Airspeed *140 km/h – 76 kts*

4.7.3 Recommended flight speed

1. Flaps *UP*
2. Airspeed *160 km/h – 86 kts*

This airspeed is a good compromise to increase forward visibility and improve engine cooling without noticeable decrease of climb performance.

4.8 Cruise

Refer to section 5, for recommended cruising figures

4.9 Descent

Maintain airspeed below V_{ne} / V_{no} depending on weather conditions.

For pilots' comfort, reduce speed in rough air conditions even below V_{no} .

For pilots' comfort, avoid rates of descent in excess of -500 ft/min.

Although the engine is equipped with a coolant thermostat, avoid sudden engine power reduction to avoid thermal shock to the engine.

4.10 Approach

- | | |
|-------------------|---------------------------|
| 1. Approach speed | - 150 km/h – 81 kts |
| 2. Flaps | - T/O position |
| 3. Seat belts | - fasten |
| 4. Altimeter | - set QNH |
| 5. LDG lights | - ON for Night VFR flight |

4.11 Landing

4.11.1 Before landing:

1. Flaps - LDG
2. Airspeed - 110 km/h – 60 kts

4.11.2 Landing

1. Throttle - Idle
2. Flare and touchdown - touch on main wheels and slowly release elevator to let the nose wheel down smoothly
3. Brakes - as required (after the nose wheel touch-down)

4.11.3 After landing

1. Flaps - UP (0°)
2. Trims - set neutral position

4.11.4 Engine shut down

1. Throttle - IDLE
2. Engine Key Switch StartAssist - OFF, remove key
3. All Switches - OFF
4. MASTER switch - OFF

4.12 Bailed landing procedure

1. Throttle - full forward
2. Airspeed - min. 115 km/h – 62 kts
3. Flaps - T/O (15°)
4. Positive climb - accelerate to 130 km/h – 70 kts
5. Flaps - UP (0°) at safe altitude
6. Throttle - set 5500 RPM max

4.13 Aircraft parking

1. Engine Key Switch StartAssist - Check OFF, keys removed
2. FLASH lights - OFF
3. LDG lights - OFF
4. Day/Night Switch - OFF (Day mode)
5. MASTER Switch - OFF
6. EMGY Switch - OFF
7. BRS handle safety pin - SECURE
8. FUEL shut-off valve - OFF
9. Parking brake - as required

5 Performance

5.1	Introduction	5-2
5.2	Stall speeds (approved data).....	5-2
5.3	Take-off	5-3
5.4	Landing distance.....	5-4
5.5	Operations on grass runways.....	5-6
5.6	Rate of climb.....	5-6
5.7	Cruise performance.....	5-7
5.8	Airspeed indicator system calibration	5-9
5.9	Cross wind	5-9
5.10	Performance degradation.....	5-9

5.1 Introduction

The presented data has been computed from actual flight tests with the aircraft and engine in good conditions and using average piloting techniques.

If not stated otherwise, the performance stated in this section is valid for maximum take-off weight 630 kg (1389 lbs) and under ISA conditions

The performance shown in this section is valid for aircraft equipped with the engine and propeller defined in section 1.

5.2 Stall speeds (approved data)

Conditions: Engine power: idle

WEIGHT	CONDITION		Stall speed							
			Bank angle							
			0°		30°		45°		60°	
		IAS	CAS	IAS	CAS	IAS	CAS	IAS	CAS	
630 kg 1389 lbs	Flaps UP (0°)	km/h	109	107	113	115	124	127	148	151
		kts	59	58	63	62	70	69	83	82
	Flaps T/O (15°)	km/h	96	94	100	101	110	112	132	133
		kts	52	51	56	55	61	60	73	72
	Flaps LDG (37°)	km/h	85	83	91	89	101	99	119	117
		kts	46	45	49	48	54	53	64	63

Note

the IAS indication provided by the analogue (E)TSO certified anemometer prevails.

Note

Maximum altitude loss during stall recovery is approximately 300 feet.

5.3 Take-off

Weight = 630 kg – 1389 lbs

Conditions:

- No wind
- Level, Hard runway
- Flaps: T/O (15°)
- Engine power: max take-off after brakes release
- Lift-off at IAS = 110 km/h (59 kts) and acceleration to IAS = 124 km/h (67 kts) (at or before a 15 m (50 ft) height)

Take-off performance at 630 kg – 1389 lbs			Temperature					
			ISA		ISA+10°C		ISA+20°C	
			T/O run >15m		T/O run >15m		T/O run >15m	
Pressure Altitude	0 ft	Meters	250	445	270	480	290	517
		Feet	820	1460	884	1575	951	1695
	2 000 ft	Meters	292	522	315	564	339	607
		Feet	959	1714	1034	1850	1113	1993
	4 000 ft	Meters	339	608	366	657	394	708
		Feet	1112	1993	1201	2155	1294	2323
	6 000 ft	Meters	398	716	430	774	464	836
		Feet	1305	2349	1410	2539	1521	2743

T/O run = take-off run

>15m = take-off distance (see definitions in §1.4.4)

5.4 Landing distance

Weight = 630 kg – 1389 lbs

Conditions:

- No wind
- Level, Hard runway
- Flaps: LDG (37°)
- Speed IAS=110 km/h – 59 kts (at a 15 m – 50 ft height)
- Engine power during approach: as required for a -3° slope
- Normal brakes operation

Landing distance at 630 kg – 1389 lbs			Temperature					
			ISA		ISA+10°C		ISA+20°C	
			LDG run > 15m		LDG run > 15m		LDG run > 15m	
Pressure Altitude	0 ft	Meters	225	575	233	583	241	591
		Feet	738	1886	764	1912	789	1938
	2 000 ft	Meters	239	589	247	597	255	605
		Feet	783	1931	810	1959	838	1986
	4 000 ft	Meters	253	603	262	612	271	621
		Feet	831	1979	861	2009	890	2039
	6 000 ft	Meters	269	619	279	629	289	639
		Feet	883	2031	915	2063	947	2095

LDG run = landing run

>15 m = landing distance (see definitions in §1.4.4)

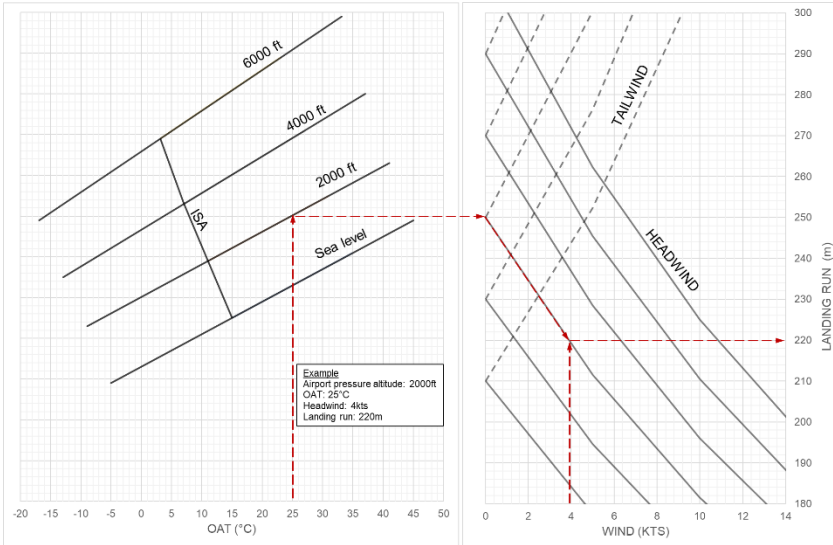

Figure 5.4-1 Landing run

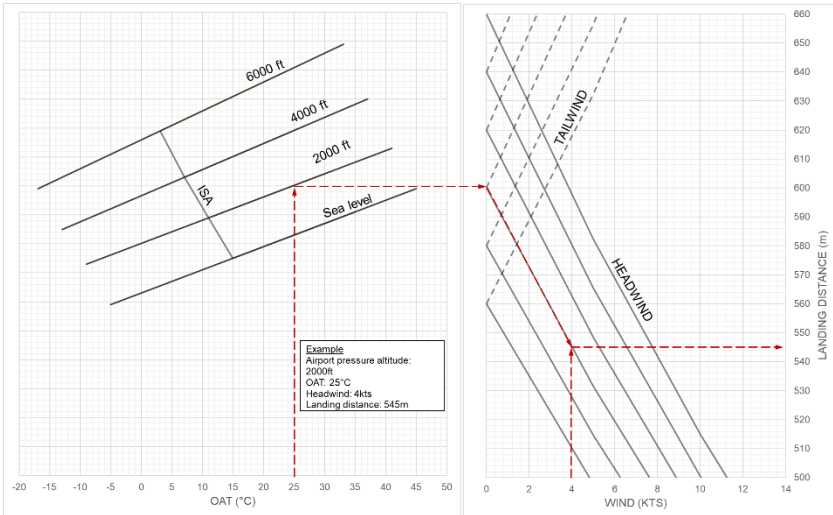

Figure 5.4-2 Landing distance

5.5 Operations on grass runways

For operation on dry grass runways, the following factors must be applied to the ground distances on a hard runway:

Take-off Dry Grass : 1.2
Landing Dry Grass : 1.2 *

If the grass is known to be wet, the factors should be

Take-off : 1.3
Landing : 1.6

Note

Due to the uncertainty of knowing if the grass is dry or wet, it is suggested that the landing factor be increased to 1.4

5.6 Rate of climb

Weight 630 kg – 1389 lbs

- Flaps: UP (0°)
- Engine power: max. continuous (Throttle – 5500 RPM)
- IAS= 140 km/h – 76 kts (best rate of climb speed)

Pressure altitude (ft)	Vz ISA ft / mn	Vz ISA+10°C ft / mn	Vz ISA+20°C ft / mn
0	1040	990	950
2 000	930	880	840
4 000	820	780	740
6 000	710	670	630
8 000	600	570	530
10 000	500	460	430
12 000	390	350	320
14 000	280	250	220
16 000	170	140	110

Rate of climb values in the table above are interpolated from flight test measures, and rounded to the nearest 10 ft/min (0.05 m/s).

- Up to 12 000 ft: Recommended speed IAS= 160 km/h – 86 kts → Decrease rate of climb in the table by 50 ft/mn
- Above 12 000 ft: Recommended speed IAS= 140 km/h – 75 kts

5.7 Cruise performance

The values provided below are only indicative. Performance can vary in a great extent depending on mass, balance, temperature, cleanliness of the airframe, piloting accuracy, weather and turbulence, ...

- “Fast cruise” is the maximum cruise speed, with engine speed at 5500 RPM.
- “Smart cruise” is a compromise between fast and economic cruise, when throttle lever is reduced just enough to activate engine ECO mode (“ECO” displayed above engine speed gauge).
- “Economy cruise” is set by controlling the fuel flow displayed on G3X EIS.

setting	Fast cruise		Smart cruise		Economy cruise	
	5500 RPM		Max ECO		15 L/h	13 L/h
Altitude (ft)	TAS (km/h)	Fuel flow (L/h)	TAS (kmh)	Fuel flow (L/h)	TAS (kmh)	TAS (kmh)
2 000	238	27	235	20	204	193
4 000	239	25	233	19	211	196
6 000	239	23	230	17	218	202
8 000	234	21	228	16	223	204
10 000	228	19	224	15	226	203
12 000	221	19	214	n/a	n/a	n/a
14 000	213	18	205	n/a	n/a	n/a
16 000	204	17	192	n/a	n/a	n/a

setting	Fast cruise		Smart cruise		Economy cruise	
	5500 RPM		Max ECO		4 gal/h	3.4 gal/h
Altitude (ft)	TAS (kts)	Fuel flow (gal/h)	TAS (kts)	Fuel flow (gal/h)	TAS (kts)	TAS (kts)
2 000	128	7.1	126	5.3	110	104
4 000	129	6.6	126	5.0	114	106
6 000	129	6.1	126	4.5	118	109
8 000	126	5.5	125	4.2	121	110
10 000	123	5.0	122	4.0	122	110
12 000	119	5.0	115	n/a	n/a	n/a
14 000	115	4.8	111	n/a	n/a	n/a
16 000	110	4.5	104	n/a	n/a	n/a

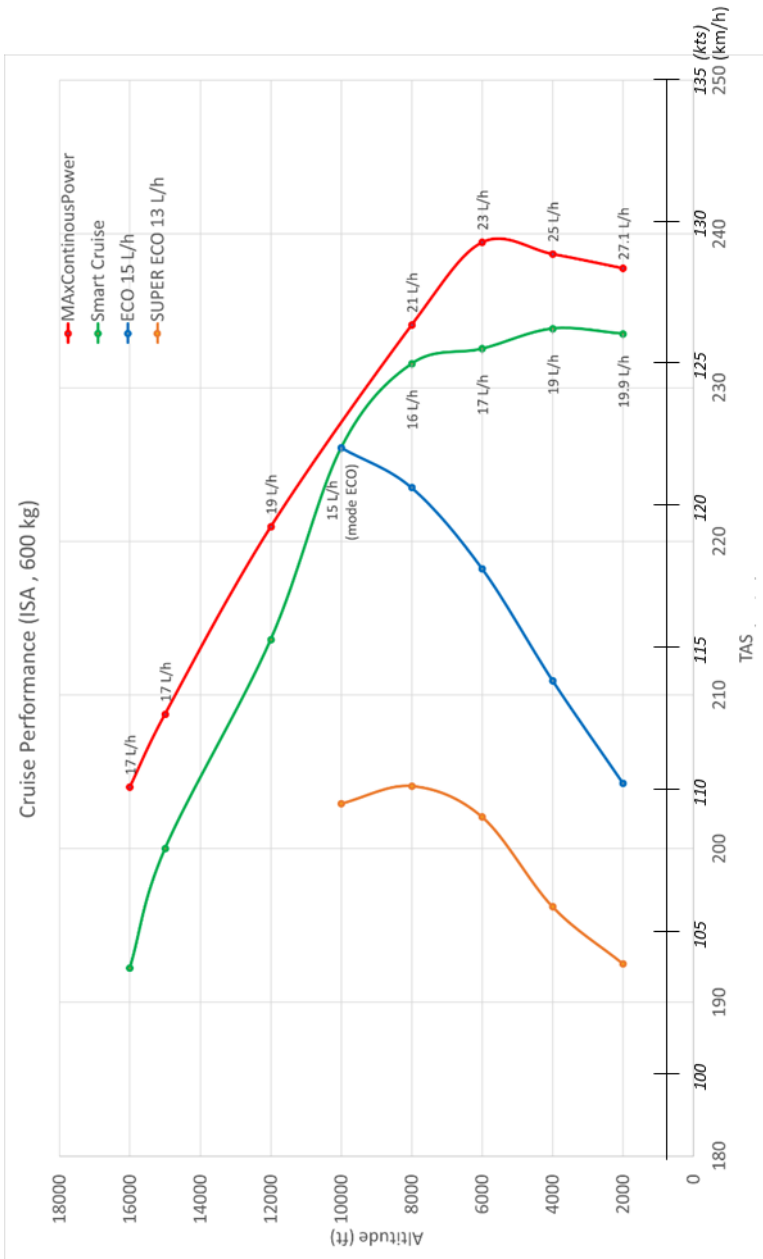

5.8 Airspeed indicator system calibration

IAS = CAS + 2 km/h (+1.1 kts) in any aircraft configuration over the whole flight envelope.

5.9 Cross wind

Max. demonstrated cross wind velocity for take-off and landing:

33km/h gusts 46 km/h

18 kts gusts 25 kts

5.10 Performance degradation

Rain and build-up of insects on lifting surfaces and fuselage reduce performance and increase stall speeds.

Intentionally left blank

6 Weight & Balance

6.1	Introduction	6-2
6.2	Airplane weighing procedure	6-2
6.3	Weight and CG limits	6-2
6.3.1	Weights	6-2
6.3.2	C.G range.....	6-2
6.3.3	Crew weight	6-2
6.3.4	Arms.....	6-2
6.4	Loading and C.G. check.....	6-3
6.4.1	Fuel weight – quantity conversion chart.....	6-4

6.1 Introduction

This section contains weight and balance information

6.2 Airplane weighing procedure

See Aircraft Maintenance Manual

6.3 Weight and CG limits

See also section 2 – limitations, chapt. 2.7 and 2.8

6.3.1 Weights

Max. take-off weight.....	630 kg – 1389 lbs
Max landing weight.....	630 kg – 1389 lbs
Max. weight of fuel.....	70 kg – 154 lbs
Max. baggage weight.....	25 kg – 55 lbs

6.3.2 C.G range

Operating C.G range..... 720 to 860 mm (28.3-33.9 in) from firewall

6.3.3 Crew weight

Check aircraft CG remains in approved limits

6.3.4 Arms

Pilot/Passenger	Seat max fwd-up : 1050 mm (41.3 in) (*)
	Seat max rear-dn : 1150 mm (45.3 in) (*)
Baggage compartment	1580 mm – 62.2 in
Fuel in tanks	774 mm – 30.5 in

(*) in case of doubt, as a conservative assumption,

- use the largest arm if the plane is rather tail heavy (two pilots, some luggage)
- use the smallest arm if the plane is rather nose heavy (one light pilot, no luggage)

Note

Empty weight includes oil, coolant, hydraulic fluid and unusable fuel.

6.4 Loading and C.G. check

1. Find empty aircraft weight, arm and moment in the weight and balance report.
2. Record pilot, passenger, baggage and fuel weights.
3. Calculate and record the moment for each item using the following formula:

$$MOMENT (kg.mm) = MASS (kg) \times ARM (mm)$$

4. Calculate and record total weight and moment.
5. Determine and record aircraft C.G. using the following formula:

$$AIRCRAFT C.G. (mm) = \frac{\sum Moments}{TOTAL WEIGHT}$$

6. Plot the point CG-MASS in the chart below and check it remains inside the approved mass-cg limits.
7. Repeat operation without fuel.

Loading verification example	Mass	x	Arm	=	Moment
Empty aircraft	360	x	673	=	242280
pilot	95	x	1150	=	109250
copilot	65	x	1050	=	68250
luggage	20	x	1580	=	31600
fuel	67	x	774	=	51858
total w/ fuel	607				503238
total w/o fuel	540				451380
CG = moment / mass					
CG departure			829		
CG arrival			836		

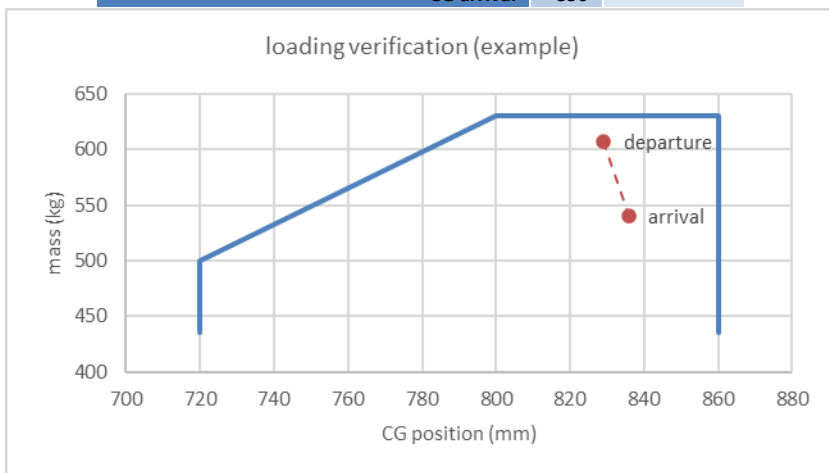

6.4.1 Fuel weight – quantity conversion chart

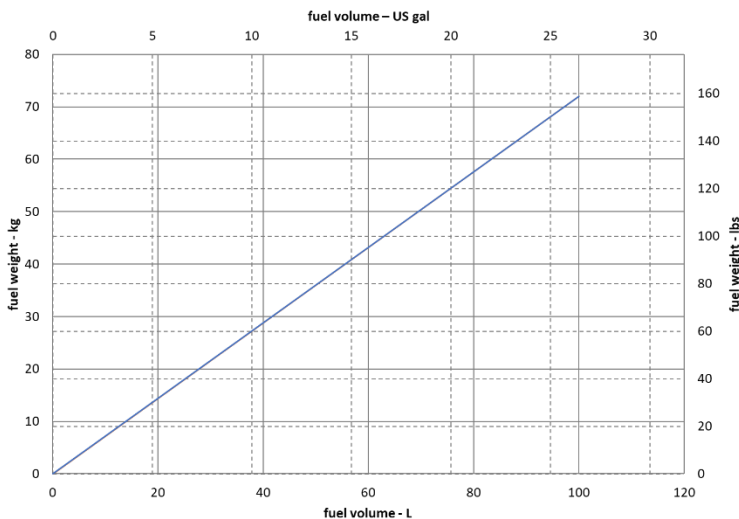

Note

fuel specific weight of 0.72 kg/L (6.01 lbs/USgal) was used to convert volume units into weight units.

Liters	0	5	10	15	20	25	30	35	40	45	50	55	60	65	70	75	80	85	90	100
US gallons	0.0	1.3	2.6	4.0	5.3	6.6	7.9	9.2	10.6	11.9	13.2	14.5	15.9	17.2	18.5	19.8	21.1	22.5	23.8	26.4
kg	0.0	3.6	7.2	10.8	14.4	18.0	21.6	25.2	28.8	32.4	36.0	39.6	43.2	46.8	50.4	54.0	57.6	61.2	64.8	72
lbs	0.0	7.9	15.9	23.8	31.7	39.7	47.6	55.6	63.5	71.4	79.4	87.3	95.2	103.2	111.1	119.0	127.0	134.9	142.9	158.7

7 Airplane & Systems Descriptions

7.1	Introduction	7-3
7.1.1	Cabin & Entry Dimensions	7-3
7.2	Instrument panel	7-3
7.3	Engine	7-5
7.3.1	Engine controls.....	7-5
7.3.2	Engine instruments.....	7-9
7.4	Propeller	7-11
7.5	Landing gear	7-11
7.6	Baggage compartment.....	7-11
7.7	Seats and safety harnesses	7-12
7.8	Canopy	7-12
7.9	Airplane parachute system.....	7-13
7.9.1	Activation Handle	7-13
7.10	Fuel system	7-14
7.10.1	Fuel tank	7-14
7.10.2	Refuelling procedure.....	7-14
7.10.3	Fuel distribution	7-15
7.10.4	Fuel shut off valve operation.....	7-15
7.11	Electrical system.....	7-16
7.11.1	Generators	7-16
7.11.2	Battery.....	7-16
7.11.3	MASTER switch.....	7-17
7.11.4	Emergency Power switch “EMGY”	7-17
7.11.5	Overvoltage circuit breaker “OVERVOLT”	7-17
7.11.6	Miscellaneous Circuit breakers and switches	7-17
7.11.7	Blow fuses.....	7-18
7.12	Instrument and avionics	7-19

7.12.1	G3X general descriptions and functions.....	7-19
7.12.2	Transponder.....	7-21
7.12.3	VHF.....	7-22
7.13	Pitot-static system.....	7-23
7.14	Safety information (Ballistic Recovery System).....	7-24
7.14.1	Introduction.....	7-24
7.14.2	Parachute system deployment scenarios.....	7-24
7.14.3	Situations where deployment is not desirable.....	7-24
7.14.4	Deployment speed.....	7-24
7.14.5	Deployment altitude.....	7-24
7.14.6	Deployment attitude.....	7-24
7.14.7	Landing considerations.....	7-25
7.14.8	Activation procedure.....	7-25

7.1 Introduction

This section provides description and operation of the aircraft and its systems. The *Elixir* aircraft is a single-engine, low-wing monoplane of monocoque structure with two side-by-side seats. The airplane is equipped with a fixed tricycle undercarriage with steering nose wheel.

The airframe makes intensive use of high-end carbon fibre prepreg technologies.

The cockpit is fitted with Garmin G3X suite including 10.6" flight display touch-screen.

7.1.1 Cabin & Entry Dimensions

Cabin Width (Maximum)..... *1,10 m - 43,3 in*

7.2 Instrument panel

1- Parachute activation Handle;	2- Engine key switch ;
3- Emergency Power switch (EMGY);	4- GDU 460 – GX3 display unit;
5- Left hand charging USB plugs;	6- Left hand pedal adjustment;
7- Altimeter;	8- Artificial horizon + slide indicator;
9- Over-voltage breaker;	10- Angle of Attack indicator;
11- Master switch;	12- Airspeed indicator;
13- Annunciators;	14- Compass;
15- TRIMS/FLAPS – breakers	16- ELT switch
17- VHF interface	18- GVNR – disconnect switch
19- FLASH/NAV/LDG - light switches	20- PEDAL - Right hand pedal adjustment
21- Right hand charging USB ports	22- FLAPS – control switch (UP - T/O - LDG)
23- PUMP - test switch (A – B)	24- LANE - selector switch (A – B)
25- Fuel shut-off valve	26- HEATER - Cabin heating
27- INSTRUMENTS – lighting dimmer	28- MAP – Map light dimmer
29- DAY/NIGHT	

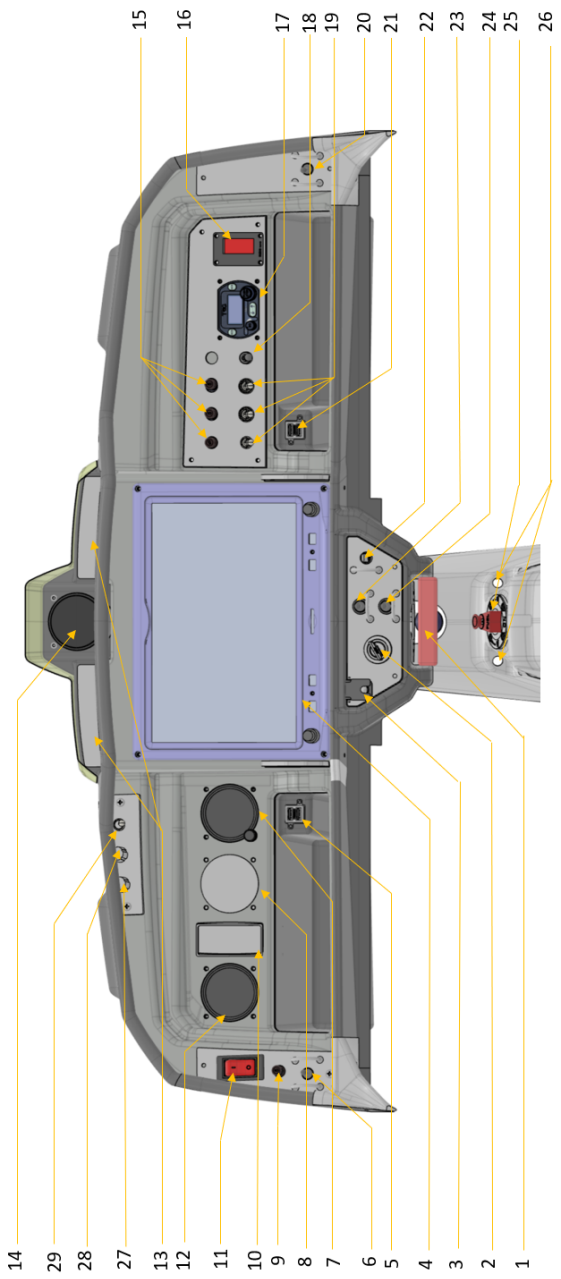

7.3 Engine

ROTAX Engine type “912 iSc 3 Sport” is installed in the Elixir aircraft.

Note

For information about this engine:

- Chapter 2.4 for engine operating limits;

- Rotax “Operator’s Manual” for engine type 912 i series.

7.3.1 Engine controls

7.3.1.1 Single Lever Power Control (SLPC)

Engine power is controlled by means of a unique throttle.

The pilot interacts with the system exclusively through the use of this single throttle lever. There is no need for other pilot control inputs (no propeller knob). The throttle lever is directly linked to the engine throttle valve with a mechanical cable. The engine ECU communicates with the SCU 9is, and the SCU 9is communicates to the Garmin G3X to display engine information.

The commanded propeller RPM is continuously computed within the SCU 9is using a control law, based on a number of engine and environmental data. A switch is positioned on the governor command for the pilot to disconnect it in case of propeller RPM commanded erroneously (oscillations, erratic behaviour...). The commanded RPM control law follows the curve below.

0	5500
10	5500
20	5500
25	5500
30	5300
40	5100
50	4900
60	4850
70	4800
85	4800
92.5	5000
97.4	5300
98.5	5500
99.5	5500
100	5800
110	5800

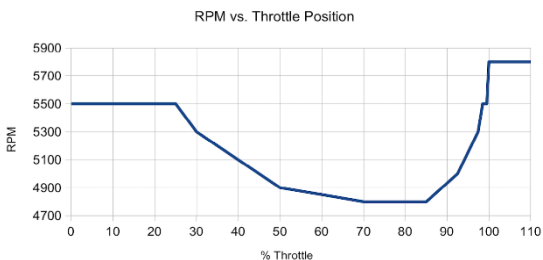

Remark : the commanded RPM is not necessary the actual RPM of the engine. With low speed and low power, the propeller hub will reach its minimum pitch stop and RPM will decrease with throttle reduction, (as would do a fixed pitch propeller).

Example : with 120 km/h IAS (65kts) and flaps T/O, steady altitude, engine revs would be approx. 4350 RPM. This is below the commanded RPM (which would be 5500 RPM in that case), which means that the propeller has reached its minimum pitch. This makes it possible to quickly reach maximum RPM if sudden application of power is required (for an emergency go-around, e.g. runway incursion...).

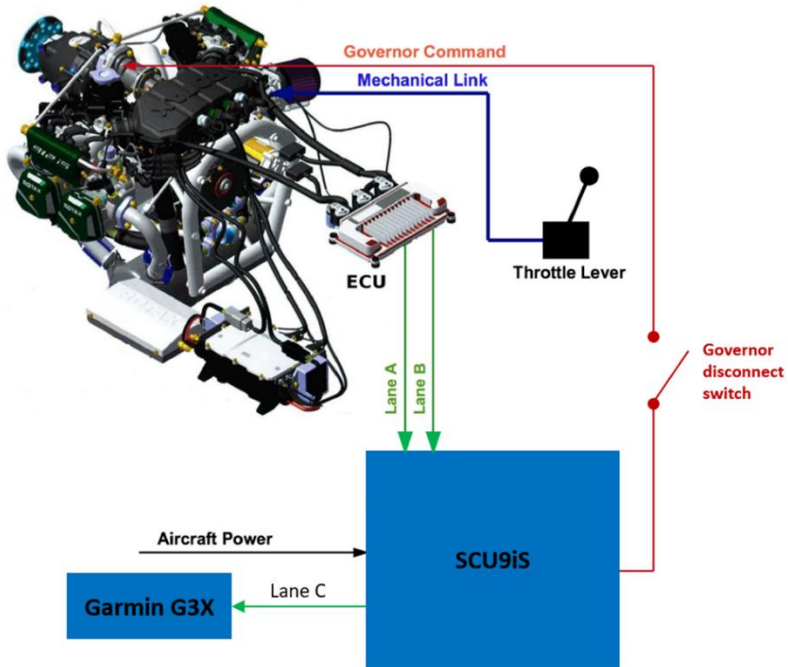
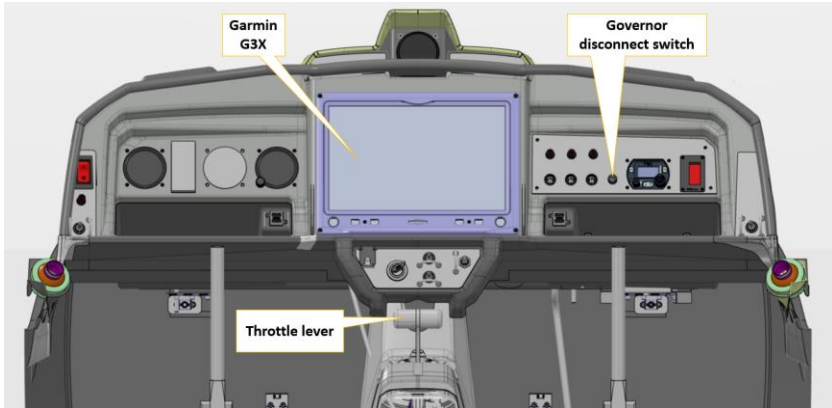

Figure 7.3-1: SLPC system architecture

The system is composed of 6 main elements:

- the Rotax 912 iS engine equipped with an electronic engine control unit (ECU)
- the MTV-34-1-A/156-203 constant speed propeller (MT propeller)
- the P-853-116 electrically driven hydraulic propeller governor (MT propeller)
- the SCU 9iS System Control Unit (RS flight system)
- the governor disconnect switch
- the throttle lever



Note

The GVNOR Governor Disconnect Switch is protected against inadvertent operation.

Note : when the GVNOR Switch is OFF, the signal to the propeller governor is disconnected. The RPM will slowly decrease until reaching the governor minimum RPM mechanical stop, regardless of engine parameter or throttle position variations. In any case, the governor mechanical stops are adjusted so that the engine speed command is mechanically contained between 4700 rpm and 5800 rpm. Therefore, regardless of RPM management system behaviour, the aircraft is always protected against:

- Engine overspeed
- Powerplant underpower / overtorque

Caution

when the GVNOR Switch is OFF , Anticipate reduced climb rate on takeoff or go around. Elixir Aircraft demonstrated 7% minimum positive climb angle at 4700rpm, max weight, sea level, in all flaps configuration with full throttle.

7.3.1.2 Engine key switch

The engine key switch **StartAssist** is a specific feature of the Elixir. The engine startup sequence is fully automated and allows you not only to save time during start up, but also to decrease the workload and the risk of mistake.

This rotary key switch includes 4 positions:

- OFF: All engine systems are OFF
- LANES: switch ON Lanes A, or B or A+B according to Lane selector switch position, and the SCU9iS System Control Unit(*)
- RUN: switch ON Electrical Pumps
- START (spring loaded): activates the starter.

For safety reasons, remove the key when engine is not running. Key can be removed only on the OFF position.

(*) the SCU9iS triggers a Start Power relay as soon as it is powered through the engine key switch **StartAssist**, the relay remains energized and the corresponding blue status light on the panel remains lit until the engine reaches 1500 rpm for the first time. As soon as this happens, the relay is deactivated and never activated again until SCU9iS is turned OFF then ON

7.3.1.3 Lane selector switch

Lane selector switch should remain on BOTH position to operate the engine normally and get the complete engine instrument display. Only use "Lane A only" or "Lane B only" positions in flight in case of engine malfunction to select the position providing the best engine operation. When a Lane is switched off, some engine information provided by that Lane to the display are lost. Primary engine information are redundant.

When only one Lane is operating, the Rotax 912iS ECO mode is not available, the engine runs only with the Power mode. This mode runs with a rich mixture, expect higher fuel consumption and reduced autonomy and range.

7.3.1.4 Pump test switch

Pump test switch is spring-loaded to ensure both pumps are running in flight.

7.3.2 Engine instruments

Garmin G3X displays all engine instruments as follow:

- | | |
|--------------------------------|--------------------------------|
| 1. Manifold pressure (in Hg) | 7. VOLTS1 (Essential bus) (V) |
| 2. Engine speed (rpm) | 8. VOLTS B (ECU B voltage) (V) |
| 3. Oil pressure (bar) | 9. Battery current (Amperes) |
| 4. Oil temperature (°C) | 10. Fuel pressure (bar) |
| 5. Exhaust gas temperature(°C) | 11. Fuel consumption (L/h) |
| 6. Coolant temperature (°C) | 12. Fuel quantity (L) |

For information about engine instruments range and marking see: Section 2 “Engine instruments markings”.

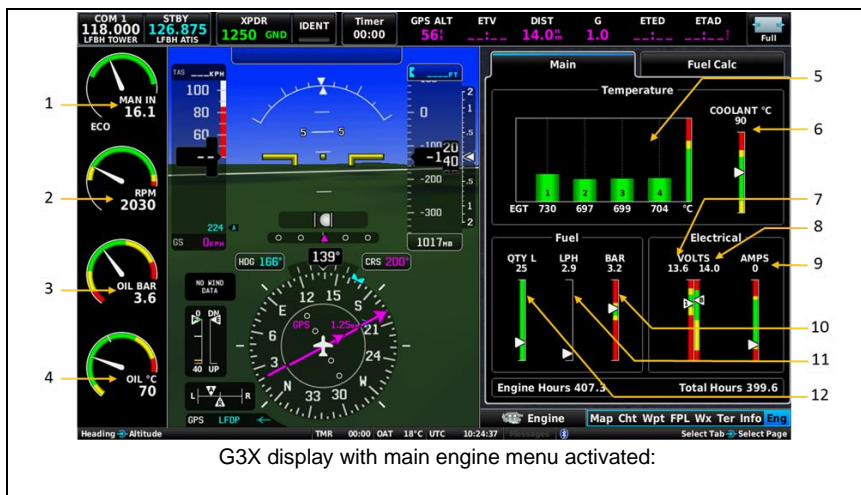

G3X display with main engine menu activated:



G3X display with Fuel Calc page activated



G3X display with main engine menu deactivated. Ex: Waypoint mode (Wpt).
Essential engine parameters remain displayed on the left column

7.4 Propeller

Propeller Manufacturer	MT-propeller	
Propeller Model Number	MTV-34-1-A/156-203	
Number of Blades	3	
Propeller Diameter	1,560 m (<i>61.4 in</i>)	
Propeller Type		three wood-composite blades, variable pitch, constant speed
Governor		P-853-116, electrically driven
Refer to section 2 for limitations.		

Note

For technical data refer to documentation supplied by the propeller manufacturer.

7.5 Landing gear

Tricycle landing gear.

Main landing gear uses oleo pneumatic shock absorbers. Each main gear wheel is equipped with disc brakes. Brakes are operated by independent brake levers (manual).

Nose wheel is steered by rudder pedals on ground. The nose landing gear is locked straight during flight, the steering springs provide rudder control spring back. For a shorter turning radius on ground, steering can be accomplished by differential application of individual main gear brakes (this must be done at very low speed only).

7.6 Baggage compartment

The rear baggage compartment is located behind seats.

Make sure that baggage does not exceed maximum allowable weight, and that the aircraft C.G. is within limits with loaded baggage.

Caution

All baggage must be properly secured.

7.7 Seats and safety harnesses

The seats can be individually adjusted on the ground to fit any size of pilots, from about 1.55 m to 2.00 m (5'-1" to 6'-7") and even more. With one hand, press the two spring-loaded locking pins behind the seat back against each other, and with the other hand, lift the seat to the position appropriate for your body size. Release the pins in the nearest adjustment hole.

WARNING

Make sure that both locking pins are fully engaged into their position before seating !

Seat cushions are removable for easy cleaning and drying.

The safety harness is of the 3-point type. The shoulder strap is mounted on a spring-retracting inertia reel. When seated, latch and tighten the belt so that your hips are held firmly into the seat.

WARNING

The hip belt must rest on your pelvis, never on your belly!
Use of the shoulder belt is mandatory.

Note

When you detach your harness, accompany the shoulder belt back to the reel. If you don't, the belt buckle may get whipped against the canopy and scratch/damage it.
Recommended : solo flight : latch the unused safety belt.

7.8 Canopy

Forward opening hinged canopy.

Two powerful gas springs lift the canopy open. The last part of the gas spring stroke has an hydraulic dampening, it is not necessary to accompany the canopy until it is fully open, unless with strong tail winds.

To close the canopy, grab the frame and pull down. Avoid pulling on the eyeball vents.

There is one latching mechanism on the top rear centre of the frame. Make sure that the canopy is latched and mechanism is securely locked into position before operating the aircraft and manually check the canopy is locked by pushing the canopy upwards.

Do not apply large forces on the canopy locking handle, on the ground and in flight. This is not a grab bar!

The canopy frame is a hollow structure made of prepreg carbon fibre. At the hinge arms, two NACA inlets collect air pressure with flight speed. Two eyeball vents are located on each side. They can be closed or open and set to any direction by the crew.

7.9 Airplane parachute system

See also § 7.14

The Elixir Aircraft is equipped with a Ballistic Recovery System designed to bring the aircraft and its occupants to the ground in the event of a life-threatening emergency. The system is intended to save lives of the occupants but will most likely destroy the aircraft and may, in adverse circumstances, cause serious injury or death to the occupants.

WARNING

The parachute system does not require electrical power for activation and can be activated at any time.

The solid propellant rocket flight path is upward from the parachute cover. Stay clear of parachute area when aircraft is occupied.

Do not allow children in the aircraft unattended.

Make sure the safety pin remains engaged as soon as the aircraft is not in use.

The system installed is BRS 1350 Softpack.

Refer to *Owner's Manual and General Installation Guide for BRS-6 Emergency Parachute Recovery Systems* for more information.

The parachute and its rocket are installed under the engine cowling, between the canopy and the firewall. When the rocket launches, the parachute assembly is extracted outward due to rocket thrust and rearward due to relative wind. When air begins to fill the parachute, forward motion of the airplane will dramatically be slowed (with an order of magnitude of 6 to 8 g's). Following a nose up pitching, the nose will gradually drop until the aircraft is hanging nose-low beneath the parachute.

WARNING

Stabilized rate of descent is in the order of magnitude of 8 m/s at MTOW.

Ground impact is expected to be equivalent to fall from a height of approximately 4 meters (13 feet). Occupants must be prepared for it in accordance with the Parachute deployment procedure in section 3.

7.9.1 Activation Handle

The Ballistic Recovery System is initiated by pulling the red T-handle installed in the cabin on the airplane center line, just under the dashboard. A safety pin prevents inadvertent activation when the aircraft is not in use. This safety pin must be removed before each flight, and secured again after each flight!

7.10 Fuel system

7.10.1 Fuel tank

The Elixir has a single tank located into the wing structure in the central spar box and through the centre wing box. It is a safety bladder tank, made of Kevlar reinforced elastomers, filled with military specification anti explosion foam. This safety fuel cell technology is similar with those used in motor racing and military programs.

The tank is equipped with two vent outlets at each wingtip, which must be kept clear. Each vent line is equipped with a calibrated check valve preventing fuel spillage in moderate uncoordinated flight and side g loads on ground, while allowing venting.

The bottom point of the tank, under the wing, is equipped with a drain. (another drain is fitted on the gascolator : check both of them during pre-flight check).

7.10.2 Refuelling procedure

The tank is equipped with two fuel caps, one on each wing. Next to each fuel cap, a label reminds approved fuel types. See also 2.12.2 above. Both fuel caps should be opened for refuelling, to help fuel transfer from one side to the other.

1. Switch off MASTER, EMGY switch, **StartAssist** switch, and remove keys,
2. Apply parking brakes,
3. Check parachute safety pin engaged,
4. Check both fuel drains are closed,
5. Connect the fuelling station grounding equipment to the exhaust pipe,
6. Check fuel grade (see 2.12.2),
7. Open both fuel caps,
8. If the wings are not level, start refuelling from the lowest wing. When the low side is almost full, close and lock the cap and finish refuelling the upper wing,
9. Check both caps are closed and locked,
10. Disconnect ground,
11. Switch G3X on, check the consistency of indicated fuel quantity. On Fuel Calc page, adjust fuel remaining quantity and reset fuel totaliser if required.

WARNING

Always keep safety in mind. Use usual safety precaution with fuel.

Caution

If you use a filler pistol, pay attention not to damage tank foam and bladder with the pistol nozzle tip.

Spilled fuel must be carefully wiped.

If the wings are not level, never unlock the lowest cap first. You may spill a large amount of fuel !

7.10.3 Fuel distribution

The fuel supply system consists in

- A submerged coarse strainer inside the tank
- A shut-off valve
- A gascolator with an average size filter and a drain
- A dual fuel pump
- A genuine fuel distributor with connections for a fine filter, its calibrated bypass, a fuel pressure sensor, and a calibrated orifice to the return line improving priming and air bubbles relief.
- Fuel lines to the engine (with fittings through the firewall)
- A fuel pressure regulator (built-in the Rotax engine)
- A return line, bringing unused fuel back from the regulator to the fuel tank
- A check valve fitted on the tank return port.

The whole system is installed in the forward central tunnel, accessible behind the forward hatch behind the front landing gear.

7.10.4 Fuel shut off valve operation

The fuel shut-off valve handle is located on the central console in the cockpit.

Fuel supply is open when the handle points forward in the "ON" position. Fuel supply is closed when the handle is turned $\frac{1}{4}$ turn either left or right in the "OFF" positions.

A spring-loaded knob on the handle lock prevents inadvertent closing of the fuel valve.

- Switching the fuel OFF requires two distinct action :

- 1- Lift knob
- 2- Rotate handle $\frac{1}{4}$ turn left or right until reaching a stop

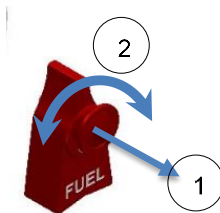

- Opening the valve only requires rotating the handle pointing forward, until the knob locks in the ON position.

Caution

Avoid prolonged fuel pump operation with fuel shut off valve closed or with empty tanks.

7.11 Electrical system

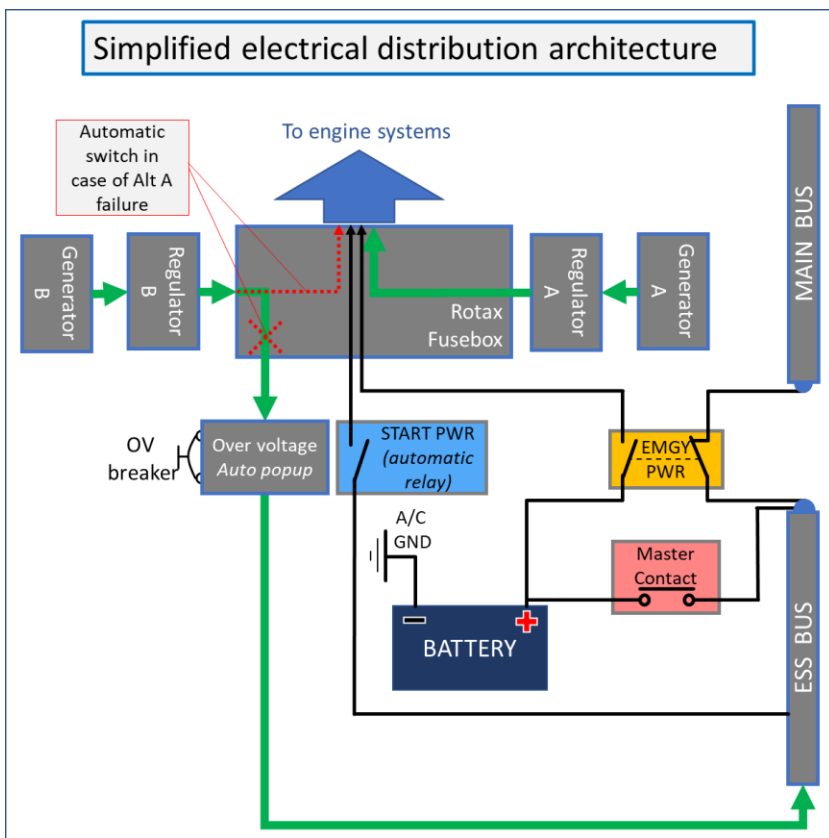

7.11.1 Generators

The Rotax 912iS engine has two individual generators A and B. During normal operation, generator A powers engine electrical systems (ECU, pumps, sensors, etc.) and generator B powers the aircraft electrical systems and charges the battery.

7.11.2 Battery

EarthX Model ETX900TSO LiFePO4 Battery is installed in the electrical compartment next to the parachute.

7.11.3 MASTER switch

The MASTER switch connects the battery and power generation to the aircraft systems.

7.11.4 Emergency Power switch “EMGY”

When EMGY is switched ON, the electrical systems of the Rotax engine are directly powered by the battery. This function is described as “Battery Backup switch” in Rotax manuals. The amber status light “EMGCY PWR” is ON.

EMGY shall be switched ON in case of dual generator failure, in which case, the engine cannot be electrically self-powered and requires battery power to run. In this case, the engine autonomy relies only on battery autonomy.

In order to increase this autonomy, when EMGY is switched ON, only the Essential aircraft systems remain powered.

Please refer to section 7.11.7 to get the list of Essential systems.

7.11.5 Overvoltage circuit breaker “OVERVOLT”

The OVERVOLT breaker located below the MASTER switch would automatically disconnect the power generation from aircraft systems if an overvoltage is detected. This breaker can also be manually pulled when an overvoltage is observed.

Note

the aircraft electrical systems would remain powered by the battery, but the battery would no longer be charged.

7.11.6 Miscellaneous Circuit breakers and switches

Circuit breakers and switches description is shown in § 7.2 above.

7.11.7 Blow fuses

The Elixir is equipped with automotive type blow fuses, located in a fuse box in the electrical compartment next to the battery under the parachute cover.

The fuse allocation chart below is placed under the fuse box cap.

MAIN					
HEATER		1	2		GI 260 AOA
GTX3X5R		3	4		Fuel level QTY
Flaps Actuator		5	6		Glareshield light
		7	8		USB
LAND LT (LDG LIGHTS)		9	10		Strobe
Pedal Adjustment		11	12		Nav Lights
BATT					
EMERGENCY POWER		13	14		EMERGENCY POWER SWITCH
		15	16		
ESSENTIAL					
GDU460 Display		17	18		GSU25 ADHARS
GEA24 EIS		19	20		GAD27 Flaps/Trim Control
Annunciator panel		21	22		TY91 VHF
Backlights		23	24		Fusebox Feed
SCU9is		25	26		Main BUS feed
Artificial Horizon		27	28		Low fuel level

If a fuse has blown, there is a reason.

If the reason is clearly identified and due to a simple mishap with no consequences, then you can replace it.

Only replace fuses with the same type and rating.

If the reason is unknown or if the fuse blows again, then maintenance is required.

Note

When the Emergency Power mode is activated (EMGY switch ON), all the equipment on the MAIN bus are switched OFF. Equipment on the ESSENTIAL bus remain powered.

7.12 Instrument and avionics

Note

For instruments and avionics operating instructions refer to the documentation supplied with the instruments and avionics.

7.12.1 G3X general descriptions and functions

Caution

This chapter is a very short description of functions, it does not replace Garmin G3X touch pilot's guide. The pilot must learn the pilot's guide and train on the G3X management on ground before using it in flight.

Note in case of indicated airspeed incoherence between the G3x and the analogue ASI, the indication provided by the analogue (E)TSO certified anemometer prevails.

The G3X can display the PFD in full screen or a split screen with PFD on the left and a secondary window on the right.

PFD is always displayed.

You can swap between split or full screen by clicking on the upper right box.

The secondary window can be:

- Map (navigation moving map)
- Cht (Chart)
- Wpt (Waypoints edition / selection)
- FPL (Flight planning edition / selection)
- Ter (Terrain)
- Info
- Eng (detailed engine parameters)

You can navigate through the available windows with the right knob.

The essential engine parameters are always displayed on the left vertical column.

You can display the detailed engine parameters window any time by clicking on the left engine vertical column. See chapter 7.3.2.



Full screen mode



Split screen mode. Example with Map zoomed on La Rochelle airport.

7.12.2 Transponder

The transponder is powered ON automatically when the MASTER SWITCH is turned ON. On the G3X touchscreen, click on the upper row XPDR section to display the transponder squawk / mode management pop-up window.



7.12.3 VHF

The Radio Trig TY91 is interfaced with the G3X. It can be controlled either from the TC90 display unit on the instrument panel or via the G3X touchscreen.

On the G3X touchscreen, click on the COM1 box in the upper row to enter the VHF frequency management screen. The following pop up window will be displayed.

Click on the “STBY” box to swap between active and standby frequencies.



7.13 Pitot-static system

The GARMIN GAP26 total pressure probe is located below the right wing. It provides a standard total pressure (front orifice) as well as a secondary pressure (lower orifice) dedicated to AOA computation. Two small orifices under the body tube are drain holes.

Keep all pitot head orifices clean to ensure proper function of the system.

It is recommended to use a dedicated “remove before flight” cover.

The total pressure is connected with flexible tubing to both the standard dial Airspeed Indicator (total pressure port) and the Garmin GSU25 ADAHRS.

The AOA pressure is connected to the ADARHS only.

Static ports are located on both fuselage sides. They location is highlighted with a sticker. Keep these orifices clean. Using obturating pins with “remove before flight” flags to avoid ingestion of water or insects is recommended.

When cleaning the aeroplane, do not direct water spray towards the static ports. If you tape them closed, make sure you remove the tape on both sides before flight.

They are connected with flexible tubing to

- The standard dial Altimeter port
- The standard dial ASI static port
- The G3X ADAHRS
- The altitude encoder for the transponder

7.14 Safety information (Ballistic Recovery System)

7.14.1 Introduction

The Elixir Aircraft is equipped with an emergency parachute. This section provides some basic instruction for safe use of the system. For more information, refer to *Owner's manual and general installation guide for BRS-6 emergency parachute recovery systems*.

7.14.2 Parachute system deployment scenarios

- Mid-Air collision
- Structural failure
- Loss of control
- Stall / Spin on approach
- Engine-out over hostile terrain
- Pilot incapacitation

7.14.3 Situations where deployment is not desirable

- Out of fuel, with reasonably large and smooth landing areas within reach
- Lost, with fuel remaining
- Fire onboard

7.14.4 Deployment speed

Refer to section 2 Limitations

Deployment at higher speeds could subject the parachute and aircraft to excessive loads that could result in structural failure. Once a decision has been made to deploy the parachute, make all reasonable efforts to slow down to the minimum possible airspeed. However, if time and altitude are critical, and/or ground impact is imminent, the BRS system should be activated regardless of airspeed.

7.14.5 Deployment altitude

No minimum altitude for deployment has been set. This is because the actual altitude loss during a particular deployment depends on many factors such as airplane's airspeed, altitude and attitude as well as environmental factors.

At any altitude, once the parachute is determined to be the only alternative available for saving the aircraft occupants, deploy the system without delay.

7.14.6 Deployment attitude

It can be assumed that to minimize the chances of parachute entanglement and reduce aircraft oscillations under the parachute, the system should be activated from a wing level, upright attitude whenever possible.

7.14.7 Landing considerations



Once the system deployed, occupants must be prepared for touchdown. All occupants must be should maintain the EMERGENCY LANDING body position until the airplane comes to a complete stop.

The EMERGENCY LANDING position is assumed with tightened seat belt and shoulder harness by placing both hands behind the head with finger locked together. The elbow should be pulled forward to protect the side of the head and face. The upper torso should be erect and against the seat backs.

7.14.8 Activation procedure

Refer to Section 3 Emergency procedures

Intentionally left blank

8 Airplane Handling, Servicing & Maintenance

8.1	Introduction	8-2
8.2	Ground handling	8-2
8.2.1	Parking	8-2
8.2.2	Jacking	8-2
8.2.3	Road transport	8-3
8.3	Towing instructions	8-3
8.4	Tie-down instructions	8-4
8.5	Servicing operating fluids	8-5
8.5.1	Approved oil grades and specifications	8-5
8.5.2	Approved coolant grades and specifications	8-5
8.6	Cleaning and care	8-6
8.7	Assembly and disassembly	8-6
8.8	Aircraft inspection periods	8-7
8.9	Aircraft alterations or repairs	8-7

8.1 Introduction

This section contains factory-recommended procedures for proper ground handling and servicing of the airplane. It also identifies certain inspection and maintenance requirements.

8.2 Ground handling

Note

It is recommended to use parking brake only for short-term parking, between flights during a flight day. After the end of the flying day or if the plane is parked on a sloping area, do not use parking brake, but use wheel chocks instead.

Note

Use anchor eyes on the wings to tie-down the airplane. Move control stick backwards and fix it with the safety belt. Make sure that the cockpit canopy is properly closed and locked.

WARNING

Never use aileron or flap hinge brackets to tie-down the aircraft.

8.2.1 Parking

It is advisable to park the airplane inside a hangar or alternatively inside any other suitable space (*garage*) with stable temperature, good ventilation, low humidity and dust-free environment.

It is necessary to moor the airplane when it is parked outside a hangar. Also when parking for a long time, cover the cockpit canopy, possibly the whole airplane by means of a suitable tarpaulin.

If rain is expected, use a canopy cover, or tape the NACA inlets.

8.2.2 Jacking

Since the empty weight of this aircraft is relatively low, two people can lift the aircraft easily. First of all prepare two suitable supports to support the aircraft. It is possible to lift the aircraft by handling the following parts:

- By pushing the fuselage rear section down in the place of a bulkhead the fuselage front section may be raised and then supported under the firewall.
- By holding the fuselage rear section under a bulkhead the fuselage rear may be raised and then supported under that bulkhead.
- To lift up a wing, push from underneath that wing only at the main spar area. Do not lift up a wing by handling the wing tip.

8.2.3 Road transport

The aircraft may be transported after loading on a suitable car trailer. It is necessary to dismantle the wings and tailplane before road transport, and use suitable conforming jigs or large amounts of foam. The aircraft and dismantled wing should be attached securely to protect these parts against possible damage.

8.3 Towing instructions

To handle the airplane on ground use the *Tow Bar*, or if pushing the airplane by hand, push on the aft fuselage, placing your hands over the fin root fairing. You can also push on the leading edges close to the fuselage, but not on the wingtips.

You can push down on the fin root fairing to lift the nose wheel and turn the plane in a narrow space.

Hand push or pull at the propeller blade roots is possible with caution. (check MASTER switch OFF, EMGY switch OFF, and StartAssist OFF !)

Caution

Do not push or pull on the propeller blade tips or on the control surfaces when towing. You can damage the propeller and the control surfaces.

Avoid excessive pressure at the airplane airframe. Keep all safety precautions, especially in the propeller area.

Never push or pull on the wingtips.

8.4 Tie-down instructions

The airplane should be moored when parked outside a hangar after the flight day. The mooring is necessary to protect the airplane against possible damage caused by wind and gusts.

For this reason the aircraft is equipped with mooring points located on the lower surfaces of the wings and below rear fuselage.

Tie-down procedure:

1. FUEL shut-off valve..... OFF
2. MASTER switch..... OFF
3. Other switches..... OFF
4. Engine Key Switch StartAssist OFF
5. Control stick..... fix using e.g. safety harness
6. Air vent..... close
7. Canopy..... close and lock
8. Moor the aircraft to the ground by means of a mooring rope passed through the mooring eyes located on the lower surfaces of the wings and below rear fuselage.

Note

In the case of long term parking, especially during winter, it is recommended to cover the cockpit canopy or possibly the whole aircraft by means of a suitable tarpaulin attached to the airframe.

8.5 Servicing operating fluids

Refer to section 2

See appropriate chapters in the ROTAX engine Maintenance and Operator's manuals for more instructions.

8.5.1 Approved oil grades and specifications

8.5.1.1 *Recommended oil type:*

Refer to Section 2

See appropriate chapters in the ROTAX engine Maintenance and Operator's manuals for more instructions.

8.5.2 Approved coolant grades and specifications

8.5.2.1 *Recommended coolant type:*

Refer to Section 2

See appropriate chapters in the ROTAX engine Maintenance and Operator's manuals for more instructions.

8.6 Cleaning and care

Use efficient cleaning detergents to clean the aircraft surface. Oil spots on the aircraft surface (*except the canopy!*) may be cleaned with petrol. The canopy may only be cleaned by washing it with a sufficient quantity of lukewarm water and/or an adequate quantity of adapted detergents. Use either a soft, clean cloth sponge or deerskin. Then use suitable polishers to clean the canopy.

Check drain holes are clear.

Caution

Never dry-clean the canopy and never use petrol or chemical solvents!

Upholstery and covers may be removed from the cockpit, brushed and eventually washed in lukewarm water with an adequate quantity of detergents. Dry the upholstery thoroughly before insertion into the cockpit.

Caution

In the case of long term parking, cover the canopy to protect the cockpit interior from direct sunshine.

8.7 Assembly and disassembly

Refer to the Elixir Aircraft Maintenance Manual.

8.8 Aircraft inspection periods

Maintenance, overhauls and time limit periods may depend on type of operation of the aircraft and its overall condition.

At least, inspections and revisions should be carried out in the periods listed in:

- Elixir aircraft Maintenance manual for aircraft maintenance and overhauls.
- Rotax engine Maintenance manual for engine maintenance and overhauls.
- MT Propeller manual for propeller maintenance and overhauls.
- Other equipment specific instructions (see also supplements)

These are minimums, maintenance instructions and periods may be reinforced under severe environment conditions but should never be made lighter.

Note

By default, aircraft maintenance should be made in accordance with AC 43.13-1B.

8.9 Aircraft alterations or repairs

It is mandatory to contact the airplane manufacturer prior to any alterations or repairs to the aircraft to ensure that the airworthiness of the aircraft is not violated.

Structural repairs must be made according to an approved repair procedure issued by Elixir Aircraft, a specific procedure may be necessary. Always use only approved raw materials and original spare parts produced by the airplane (engine, propeller) manufacturer.

If the aircraft weight is affected by any alteration, a new weighing is necessary unless the new mass and CG can be exactly computed, then record the new empty weight into the Weight and Balance record.

Please refer to Elixir AMM.

Note

Aircraft repairs should be made in accordance with AC 43.13-1B

Intentionally left blank

9 Supplements

9.1	Introduction	9-2
9.2	Inserted supplement.....	9-2

9.1 Introduction

This section contains the appropriate supplements necessary to operate the aircraft safely and efficiently when equipped with various optional systems and equipment not provided with the standard airplane.

9.2 Inserted supplement

This table must be completed and updated by the aircraft owner, with approved documents, independently for each aircraft in service according to its actual configuration. This list should not be limited to Elixir Aircraft documents, the owner is required to insert any approved documents corresponding to any approved third-party equipment or modifications added or removed during the life of the aircraft.

Elixir Serial Number	Registration Marks :

Author.	Reference / title	Edition / revision	Date of insertion
Elixir Aircraft	LXR-AI-Rec-Manual-AFM SUP01 Garmin AutoPilot		
Elixir Aircraft	LXR-AI-Rec-Manual-AFM SUP02 Heated pitot		
Elixir Aircraft	LXR-AI-Rec-Manual-AFM SUP03 ADSB IN OUT		
		
Garmin	G3X Touch Pilot's Guide		
		

10 Supplemental procedures

10.1 Introduction	10-1
10.2 Steep approach.....	10-2

10.1 Introduction

This section contains the approved supplemental procedures.

10.2 Steep approach

If operational circumstances require steeper approach slopes than normal procedure, the following procedure can be applied in order to reduce landing distance or improve obstacle clearance:

The following procedure at a -9% approach slope has been validated:

- | | |
|--------------------------|---|
| 1. <i>Flaps</i> | • <i>LDG</i> |
| 2. <i>Descent rate</i> | • <i>-550 ft/mn (Sea Level – ISA – no wind)</i> |
| 3. <i>Approach speed</i> | • <i>110 km/h – 60 kts</i> |

Notes:

The max slope at idle is -13.5% for the conditions mentioned above.

Tail wind should be avoided as far as possible.

The procedure above leads to the following landing distances at max weight (630 kg):

Landing distance at 630 kg – 1389 lbs			Temperature					
			ISA		ISA+10°C		ISA+20°C	
			LDG run	>15m	LDG run	>15m	LDG run	>15m
Pressure altitude	0 ft	Meters	145	365	150	370	155	375
		Feet	476	1198	492	1214	509	1231
	2 000 ft	Meters	154	374	159	379	167	387
		Feet	505	1226	522	1244	547	1268
	4 000 ft	Meters	163	383	169	389	179	399
		Feet	536	1257	555	1277	588	1310
	6 000 ft	Meters	173	393	180	400	193	413
		Feet	569	1291	590	1312	634	1356

Note

Be aware that before landing on a short runway, the pilot should verify that the take-off distance available on the airfield is compatible with published take-off distance.

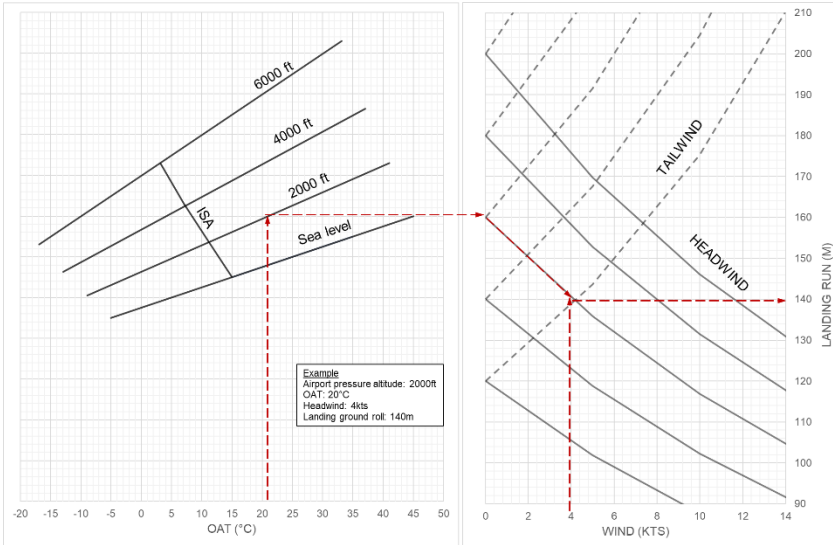

Figure 10.2-1 : landing run - steep approach

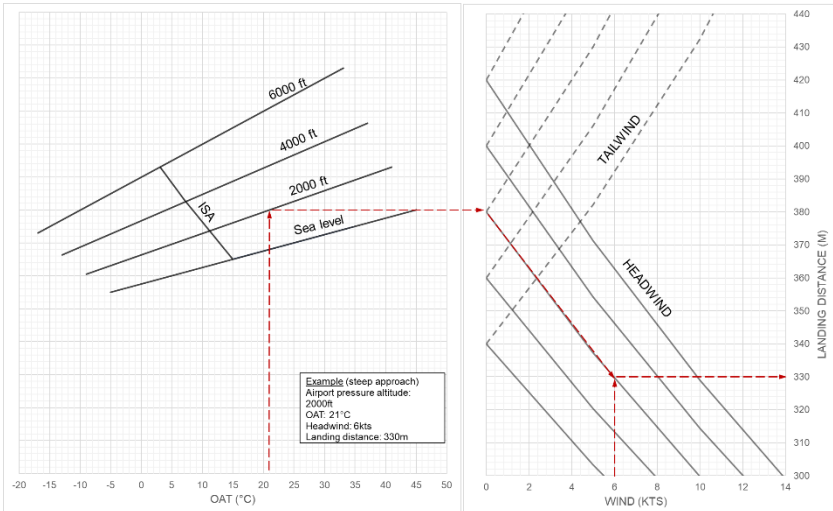

Figure 10.2-2 : landing distance - steep approach



Elixir Aircraft

Aéroport de La Rochelle - Ile de Ré – LFBH

Lat : 46° 10' 45" N – Long : 001° 11' 43" W

Rue du Jura

17 000 La Rochelle - France

www.elixir-aircraft.com